



26cc Petrol Pole
Hedge Trimmer
WEPHT26
193879001

Operator's Manual & Parts List

Please read & understand this manual, paying particular attention to the safety instructions, before use.
The manufacturer reserves the right to change the product specification and livery according to continued product improvements.

23 Nov 2015







CONTENTS

SAFETY INSTRUCTIONS

SPECIFICATIONS

COMPONENTS

ASSEMBLY

OPERATION

MAINTENANCE, CLEANING & STORAGE

TROUBLE SHOOTING

PARTS DIAGRAM & LIST

DECLARATION OF CONFORMITY

WARRANTY

For Spares or Support of your Webb product, please contact us:

Tel: 01793 333212

(Mon – Fri 8.30am to 5.00pm)

Email: customerservice@webblawnmowers.co.uk













To view the full range or find out more information go to

www.webblawnmowers.co.uk

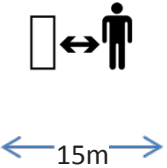
INSTRUCTION MANUAL

SAFETY INSTRUCTIONS

Read and understand the owner's manual and labels affixed to the machine. Learn its application and limitations as well as the specific potential hazards. Retain these instructions for future reference. The operator is responsible for following the warnings & instructions in this manual and on the product.

	Read & understand operator's manual before using the machine. Failure to follow instructions could result in death or serious injury.		This graphic and when accompanied by WARNING or DANGER , calls attention to actions which could lead to SERIOUS INJURY
	Always wear eye and ear protection		Always TURN OFF THE ENGINE , ensuring the cutting tool has stopped, before cleaning, removing or adjusting the blade.
	Always wear gloves to protect your hands. SHARP ROTATING BLADES		Wear foot protection or sensible shoes when using the machine
	WARNING Never modify a machine in any way. Incorrect use of a machine can cause SERIOUS OR FATAL PERSONAL INJURY		Keep all bystanders & animals at least 15 metres away from the machine during operation. If approached, stop the machine immediately.
	No smoking		Risk of Carbon Monoxide Poisoning. Ensure working area is correctly ventilated.
	Do not use near a flame, or sparks		Fire Risk Fire and its vapors are extremely flammable & explosive. Fire or explosion can cause severe burns or death.
	Moving Parts Rotating parts can contact or entangle hands, feet, hair, clothing or accessories. Traumatic amputation or severe laceration can result		Hot Surface. Running engines produce heat. Engine parts, especially the exhaust, become extremely hot. Severe thermal burns can occur on contact



Safety alert symbol. Used to alert you to potential personal injury hazards. Obey all safety messages that follow this symbol to avoid possible injury.



DANGER

Indicates an imminently hazardous situation which, if not avoided, will result in serious injury.



WARNING

Indicates a potentially hazardous situation which, if not avoided, could result in serious injury



CAUTION

Indicates a potentially hazardous situation which, if not avoided, may result in minor or moderate injury.

CAUTION

Used without the safety alert symbol indicates a potentially hazardous situation which, if not avoided, may result in property damage.



STAY ALERT

Do not operate the machine while under the influence of drugs, alcohol, or any medication that could affect your ability to use it properly. Do not use this machine when you are tired or distracted from the job at hand. Be aware of what you are doing at all times. Use common sense.

AVOID DANGEROUS CONDITIONS

Make sure there is adequate surrounding workspace. Cluttered areas invite injuries.

Keep your work area clean with sufficient light. Keep area around the machine clear of obstructions, stones, sticks, wires and other debris or foreign bodies which could cause damage to the machine.

DO NOT SMOKE, whilst using the machine.

INSPECT YOUR MACHINE

Check all bolts, nuts, and screws for tightness before each use, especially those securing guards and drive mechanisms. Vibration during use may cause these to loosen.

Replace damaged, missing or failed parts before using.

Warning labels carry important information.

Replace any missing or damaged warning labels.

DRESS PROPERLY

Do not wear loose clothing, gloves, scarfs, neckties or jewelry (rings, wrist watches), which can be caught in moving parts.

ALWAYS wear protective eye and ear wear. Appropriate gloves are also recommended.

Wear protective hair covering to contain long hair, preventing it from getting caught in machinery.

DO NOT use whilst barefoot or wearing open toed footwear.

KEEP BYSTANDERS AND CHILDREN AWAY

Keep unauthorised persons or animals a minimum distance of 15 metres away from the mower. Do not allow children to handle, use, or climb on the machine.

DO NOT OVERREACH

Keep proper footing and balance at all times, particularly if using on slopes. The machine should not be used on steep slopes and always be sure of footing.

AVOID INJURY FROM UNEXPECTED ACCIDENT

Keep hands out of the way of moving parts, particularly the engine and rotating cutting tool.

DO NOT FORCE TOOL

Always work within the rated capacity. Do not use the machine for a purpose for which it was not intended. Always use the correct handles and shoulder straps provided with the machine.

MAINTAIN YOUR MACHINE WITH CARE

Clean the machine immediately after use. Keep the machine clean to ensure it operates to its full and safest performance. When maintaining this machine, only the manufacturer's original replacement parts should be used. The use of non-original manufacturer parts may invalidate your warranty.

STORE IDLE EQUIPMENT

When not in use, the machine should be stored in a dry location. Keep the machine away from children and others not qualified to use it. DO NOT STORE FUEL IN THE MACHINE, fuel over 30 days old can become stale and if used, damage the carburetor, which is not covered by the manufacturer's warranty.



INSTRUCTION MANUAL

SPECIFICATIONS

Model	WEPHT26
Product Number	193879001
Engine (cc)	25.4
Idle Speed (r/min)	2800
Carburetor	Diaphragm
Fuel Tank Capacity (Litre)	0.45
Fuel Ratio (Petrol:2 Stroke Mineral Oil)	25:1
Overall Size (mm)	L 2300 - W 250 - H 250
Total Teeth	28
Max Cutting Diameter (mm)	25
Weight (kgs)	N.W 6.5 - G.W 9.5

The manufacturer reserves the right to change the product specification and livery according to continued product improvements.



This symbol on the product or on its packaging indicates that this product may not be treated as household waste. Instead it shall be handed over to the applicable collection point for the recycling of electrical and electronic equipment.

For more detailed information about recycling of this product, please contact your local council office, your household waste disposal service or shop where you purchased the product.



COMPONENTS

1. D-Handle
2. Harness Eyelet
3. Ignition Switch
4. Throttle Cable
5. Throttle Lever
6. Safety Lever
7. Driveshaft
8. Hand Wheel & Coupler
9. Exhaust Fuel Tank Cap
10. Recoil Starter
11. Fuel Tank
12. Primer Bulb
13. Choke Lever
14. Air Filter Cover
15. Blade
16. Angle Adjuster

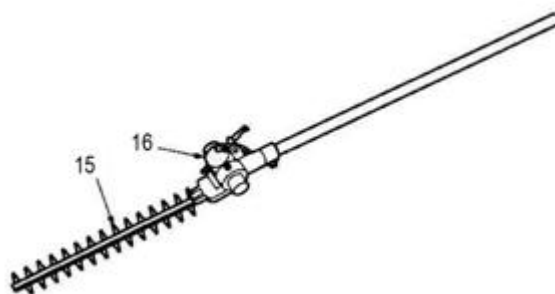
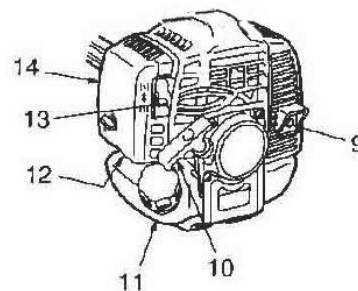
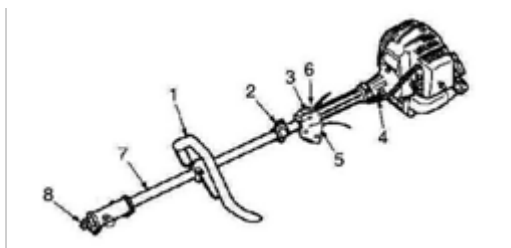

INSTRUCTION MANUAL

ASSEMBLY

Remove the machine and contents from the carton. Be sure the carton is empty before discarding.

If you require any assistance with regards to the contents of the lawnmower contact us:

Tel: 01793 333212 - Mon – Fri 8.30am – 5.00pm (excl. Bank Holidays)

Email: customerservice@webblawnmowers.co.uk

FITTING D-HANDLE

1. Place top handle onto driveshaft.
2. Position lower handle, beneath the top handle in a comfortable operating position
3. Tighten the four fixing screws.

FITTING THE HARNESS

1. Place the clasp of the harness, through the Harness Eyelet located on the driveshaft
2. Adjust the Harness to ensure it is comfortable, but tight enough to allow you to operate the machine appropriately.

JOINING ATTACHMENT TO THE POWER UNIT

1. Untighten the handwheel, located on the coupler.
2. Line up the attachment shaft with the coupler and insert, pulling the locking pin on the coupler out to house the attachment.
3. When fully housed, secure by tightening the handwheel.

STEP 4 - ADJUSTING THE CUTTING HEAD ANGLE

1. Stop the engine
2. Turn the clamp lever anti-clockwise to loosen
3. Adjust the blade to the required angle, by moving the clamp level up or down the angle adjuster.
4. Turn the clamp lever clockwise to tighten.

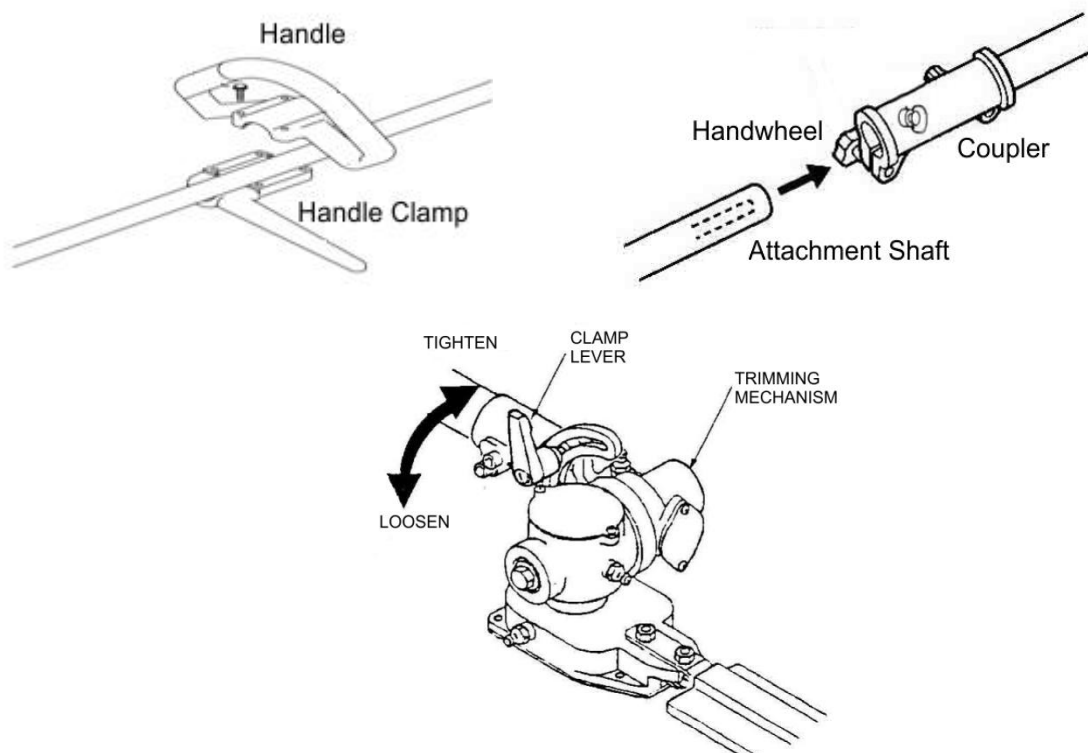

WARNING

EXCESSIVE VIBRATION OF THE BLADE INDICATES IT HAS NOT BEEN INSTALLED CORRECTLY.

STOP THE ENGINE IMMEDIATELY, CHECK THE BLADE INSTALLATION AND RE-INSTALL CORRECTLY. AN INCORRECTLY INSTALLED BLADE CAN CAUSE INJURY.



OPERATION



DANGER

All Hedge Trimmers can throw debris, metal or small objects as well as material being cut. Do not allow anyone to enter the operating DANGER ZONE with you. The danger zone is an area 15 metres in radius. Insist that persons in the RISK ZONE beyond the danger zone wear eye protection from thrown objects. If the unit must be used where there are unprotected people, operate at a low throttle speed to reduce the risk of thrown objects.

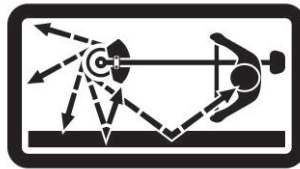

DANGER ZONE WITHIN 15 METRES - RISK ZONE GREATER THAN 15 METRES

GENERAL USE



WARNING

Prior to using the machine, ensure all hardware (bolts, screws & nuts) are securely tightened.

Operate the trigger with your right hand & hold the D-Handle with your left hand.

The trigger increases and decreases the power of the engine to the attachment, increasing the revolution/reciprocation of the attachment.

WORKING PLAN

Limit the amount of time the product is used continuously to a maximum of 40 minutes per session.

Leave the machine to rest between sessions for between 10-20 minutes.

Total amount of work performed per day with the machine, should be limited to 120 minutes maximum.

Continuous use of the machine can cause "Repetitive Stress Injury (RSI)". If you feel discomfort, redness or swelling of your hands and fingers or any other body part, consult your doctor.

Check local regulations for sound level and hours of operation constraints.

Never transport the machine, whilst the engine is running.



INSTRUCTION MANUAL

HEDGE CUTTER

To adjust the angle of the Hedgecutter, loosen the locking lever; rotate the Hedgecutter head to the desired angle. Tighten the locking lever to the adjuster; ensuring blade is secure, before operating.



Always have a firm footing and use two hands to hold the machine

It is advisable to cut a hedge from the bottom up, sweeping the cutter head in an arc as you move along the hedge. The double edged cutter blades allow cutting of your hedge in both directions.

To cut the top of the hedge, adjust the cutter head to a horizontal position. Hold the cutter head at an angle of 0-10 degrees as you sweep the head in an arc across the top of your hedge, towards the outside to allow cuttings to fall to the ground.

Pay special attention to hedges which are positioned along wire fencing. If the cutting blades make contact with the fence, damage may occur.

Do not use the Hedgecutter Attachment for periods greater than 45 minutes. Take a break for 10-15 minutes or after using one tank of fuel.

If the blade comes into contact with a stone, wire or other foreign object, stop immediately and check for any damage to the blades immediately.

Do not attempt to remove any twigs or branches jammed in the cutter blades, without first turning the engine off.

Always check for any damage before each use and replace a damaged blade immediately, with an approved replacement part. A

Always fit the supplied blade guard when the Hedgecutter Attachment is not in use.



FUEL & OIL MIXTURE



Fuel & its vapors are very flammable. Do not use or fuel the machine near a flame, sparks or while smoking. Allow the engine to cool for more than 2 minutes, before re-fueling. Never fuel the machine with the engine running. Fuel the engine at least 3 metres away from your work area. Always fuel your machine outdoors.

- ☒ Use good quality unleaded fuel which contains NO ETHANOL or METHANOL. Use Branded 89 octane or higher unleaded fuel, known to be of good quality.
- ☒ Fuel which is older than 30 days old can become stale and cause acid & gum deposits in the fuel system or essential carburetor components. This could result in starting issues which **would not be covered by your manufacturer's warranty**.

To keep fuel fresh, we recommend you use ***Handy Parts – Sure Start Garden Machinery Fuel Additive*** which is available in 250ml bottles, for 25 litres of fuel.

- ☒ **Helps makes machines easier to start**
 - ☒ **Extends shelf life of petrol up to 2 years**
 - ☒ **Keeps carburetor & engine clean**
 - ☒ **Reduces emissions & increases fuel economy**
- ☒ Only use 2-stroke air cooled engine oil. DO NOT USE automotive or marine oil.
 - ☒ It is recommended that you use a Fuel Mixing Bottle, to ensure the correct fuel mixture is used with your machine. We recommend Handy Parts item HP-120. The fuel mixture should be shaken prior to entering the machine fuel tank.
 - ☒ Mix only the quantity you require to complete your specific task.

Fuel Mixture Ratio - 25:1 (Unleaded Petrol 25:1 2-stroke Mineral Oil)
If using Synthetic or Semi Synthetic Oil, consult the Oil manufacturers instructions

25:1 Fuel Mixture Ratio

Unleaded Petrol – litre	Two-Stroke Mineral Oil - ml
1	40
2	80
3	120
4	160
5	200

- ☒ Unscrew the machine fuel cap slowly and fill the fuel tank with your fuel mixture to a maximum of 80% capacity. This will allow for fuel tank expansion.
- ☒ Fasten the fuel cap tightly, being careful not to cross-thread. This will also prevent loosening through vibration during use.
- ☒ Wipe away any spillage, with an appropriate material.
- ☒ If the machine has continued leaks, the product should not be started. Never use the machine with damaged ignition cable or spark plug cap, as there is a risk of sparks.

IMPORTANT

- ☒ Ensure that any stored petrol/oil mixture is clearly marked in a separate appropriate canister for a maximum of 4-6 weeks.
- ☒ If the machine is not going to be used for a long period, drain the mixture from the fuel tank, start the engine and drain the carburetor of any remaining fuel. (See Maintenance for further instruction)
- ☒ Dispose of any unwanted 2-stroke mixture at an authorised recycling point.

INSTRUCTION MANUAL

ENGINE STARTING & STOPPING PROCEDURE

STARTING A COLD ENGINE

1. Place the machine onto a flat, firm surface.
2. Keep the cutting head off of the ground and clear of any surrounding objects
3. Move the stop switch to "START" position
4. Give a gentle push on the primer pump repeatedly (7-10 times) until fuel comes into the primer pump.
5. Pull the Choke Lever up to close the choke
6. Whilst holding the machine down with your left hand, away from the engine and pull the engine recoil starter rope vigorously, until the engine false starts.

(DO NOT LET THE RECOIL STARTER ROPE RETRACT BY ITSELF, FEED THE ROPE BACK INTO THE HOUSING)

7. Push the choke lever downwards (excessive cranking with choke lever up will cause the engine to flood, making it difficult to start.)
8. Pull starter handle until engine starts.
9. Allow engine to warm up for a few minutes before using.

STARTING A WARM ENGINE

1. Move the switch to "START" position
2. If the fuel tank was run dry on previous operation, follow steps 3-7 of cold start procedure.
3. Whilst holding the machine down with your left hand, away from the engine and pull the engine recoil starter rope vigorously, until the engine false starts.

STOPPING THE ENGINE

1. Move the stop switch to the "STOP" position

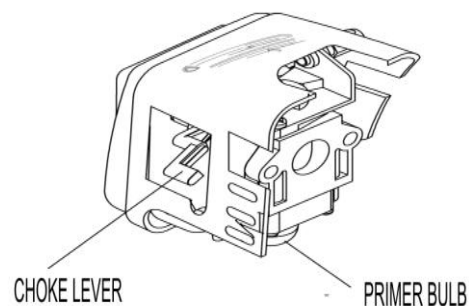
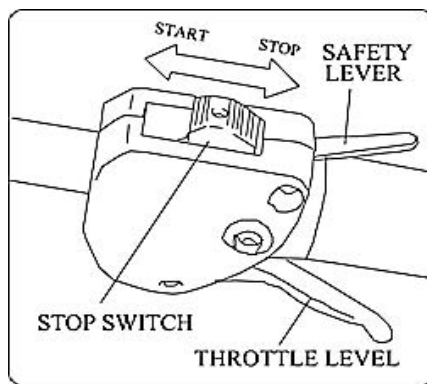
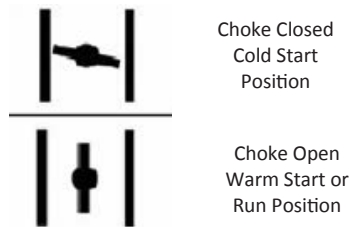

WARNING

Do not cut where you cannot see what the cutting tool is cutting. DO NOT use the put the metal blade into contact with Utility Wires, Metal Stakes, Rubber, Masonry, Rocks, Fences, and Trees.

DANGER

DO NOT cut with a dull, cracked or damaged blade. Before cutting, inspect for obstructions. If an obstruction cannot be removed, mark its location clearly so you can avoid it during operation. Rocks & metal can dull or damage a blade. Wires can wrap around the blade head or be thrown in the air.



MAINTENANCE, CLEANING & STORAGE



WARNING

Improper maintenance & storage of the machine may void your warranty. Keep the machine clean for better and safer performance.

MAINTENANCE

Before each use, check all nuts & bolts to be sure they are sufficiently tightened.

We recommend only manufacturer original parts are used when maintaining this machine. Failure to do so could invalidate your manufacturer's warranty.

The engine must be switched off, with the spark plug cap removed, before the machine is unassembled, cleaned, serviced or maintained.

POWER UNIT

ADJUSTING CARBURETOR

Do not adjust carburetor unless necessary. If you have trouble with the carburetor, see your dealer. Improper adjustment may cause engine damage and void warranty.

SPARK PLUG

Do not attempt to remove the plug from a hot engine in order to avoid possible damage to the threads.

Clean or replace the plug if fouled with heavy oily deposits.

Replace the plug if the center electrode is worn or rounded at the end.

The spark gap should be 0.6-0.7mm (.023".028")

HEDGE CUTTER

BLADES

The cutting blades can be protected and kept lubricated by periodically applying Maintenance Lubricating Oil.

If a gap exists between the upper & lower blades, follow the below steps to adjust them, so that they are closer together and cutting to their optimum performance.

Loosen locknut (A) as shown below, with a spanner.

Tighten screw (B) fully, and then loosen by a half rotation with a screwdriver.

While holding the screw in position with a screwdriver, tighten the locknut with a spanner.

Check to make sure, flat washer (C) is loose enough to be turned by your finger.

Tightening the screw too tightly may make it impossible for the blades to move. Conversely, not tightening the screw sufficiently may make the blades feel dull and cause leaves and branches to become caught in the blades.

GEAR CASE

The gears are lubricated by Multi-purpose Lithium based grease in the gear case. Input new grease **EVERY 25 HOURS** of use or more often, depending on the use conditions.

When adding lubricant, use a grease gun to insert the grease into the three grease nipples located on the gear case.

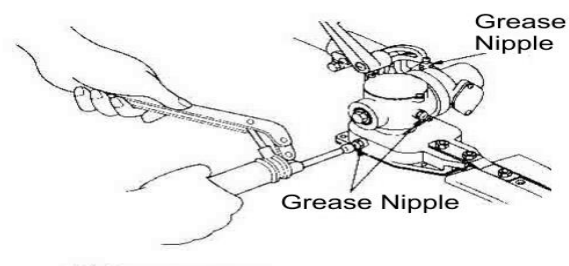
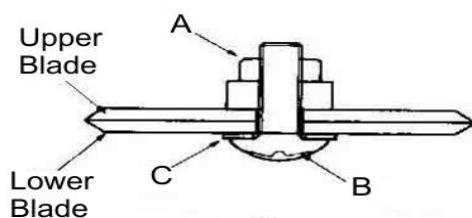

INSTRUCTION MANUAL

CLEANING

Keep your machine clean.

Thoroughly clean the machine at the end of each use, paying particular attention to cuttings in and around the guard and cutting tool.

AIR FILTER

Accumulated dust in the air filter will reduce engine efficiency, increase fuel consumption and allow abrasive particles to pass in the engine. Remove & clean the air filter regularly to ensure optimum performance.

Remove the air filter cover, by releasing the securing winged screw from the front of the cover.

Lift off the cover.

Remove the sponge air filter from the housing.

Tap the filter to remove light surface dust.

Heavy deposits should be washed out of the Air Filter in soapy water. Allow the filter to dry completely.

FUEL FILTER

The fuel tank is fitted with a filter. It is situated at the free end of fuel pipe and can be picked out through the fuel filler neck, with a piece of hooked wire or similar.

Check the fuel filter periodically. Do not allow dust to enter into the fuel tank. A clogged filter will cause difficulty in starting the engine or abnormalities in engine performance.

When the filter is dirty, replace the filter.

When the inside of the fuel tank is dirty, it can be cleaned by rinsing the tank out with petrol.

STORAGE

For years of trouble free service, make sure the machine is clean and dry before storing.

Before storing, clean the machine thoroughly as indicated above.

Store indoors or in a safe, locked protected area during severe weather and winter months.

DO NOT STORE in an enclosed area, where fuel vapors can reach an open hot flame.

DO NOT STORE fuel in the machine. Ensure fuel is removed from the fuel tank and carburetor.

If storing for an extended period, inspect, clean and repair the machine if necessary. Remove all fuel from the fuel tank. Start the engine, this will remove all fuel from the carburetor and fuel lines. Remove the spark plug, pour a small quantity of 2-stroke oil into the spark plug hole of the cylinder and re-seat spark plug. Store in a clean, dry, dust free area.

DO NOT STORE fuel for longer than 30 days. Fuel can become stale and cause damage to the engine carburetor, which is not covered by the machines manufacturer's warranty.

TROUBLE SHOOTING

Failures such as a difficulty in starting the engine, irregularity in functions and abnormality in performance can normally be prevented if careful attention is paid to all operating instructions and maintenance procedures.

Should the engine not function properly, check the following?

That the fuel system is in good condition and fuel is flowing to the engine.

The ignition system is in good condition and the spark plug, sparks correctly.

Compression of the engine is adequate.

FAILURE TO START

Correctly follow the starting procedure, not setting the choke lever or priming the engine can cause the engine to not start.

Dispose of fuel from the tank, particularly if over 30 days old.

Ensure that fuel is fresh and clean.

Check fuel filter to ensure it is clean. (Replace filter if necessary).

Make sure air filter elements are clean.

Install a new, properly gapped spark plug.

When there is serious trouble with the unit, do not try to repair it yourself, but have your local approved service dealer inspect it for you.



PARTS DIAGRAM - WEPHT26 Engine

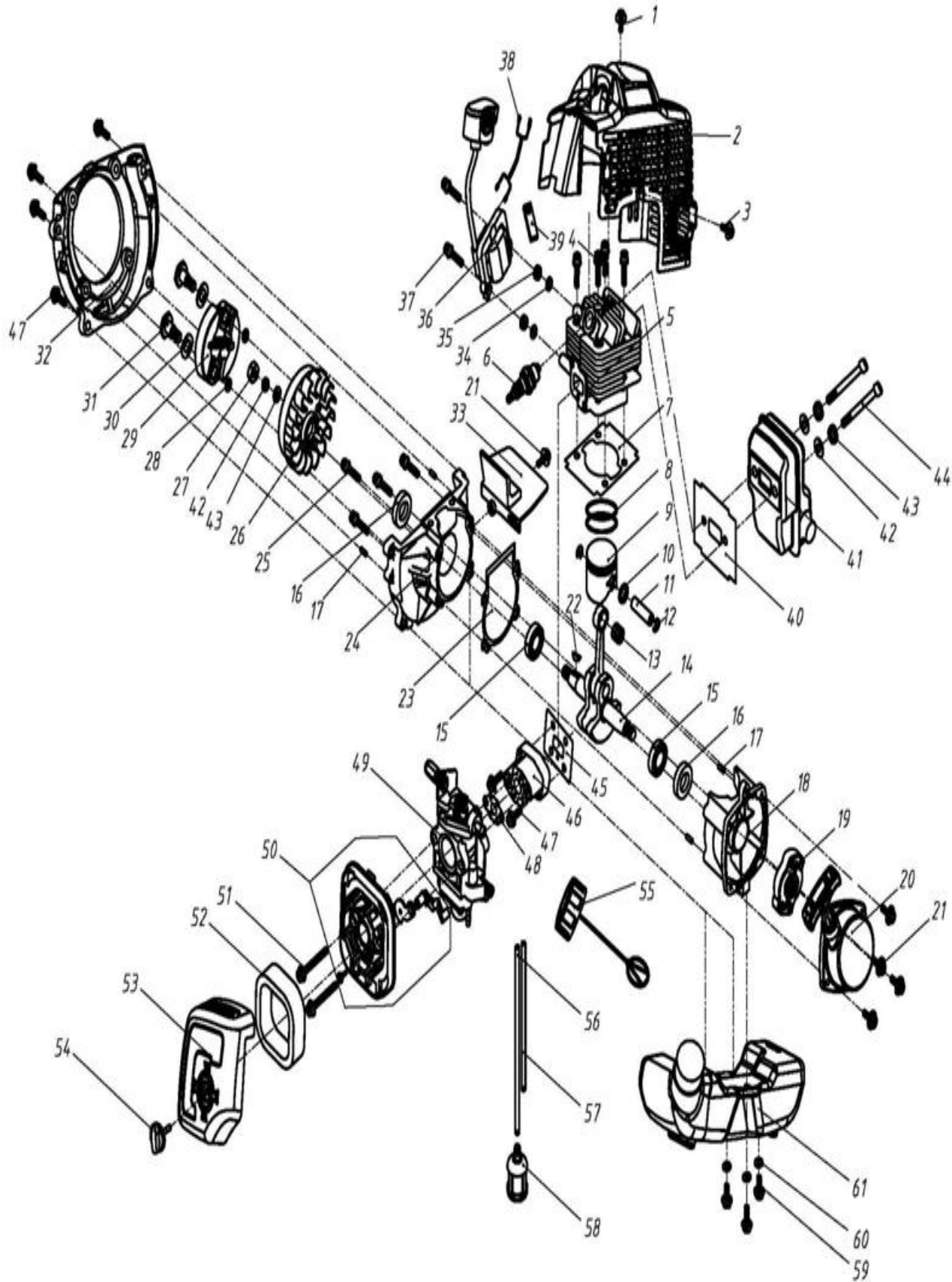

PARTS LIST - WEPHT26 Engine

Item No.	Part No.	Description	Qty	Item No.	Part No.	Description	Qty
1	WE03010110121	Screw M5x12	1	32	WE70070030026	Cover	1
2	WE70030030853	Engine Cowling	1	33	WE70030030164	Guide	1
3	WE03020020055	Screw GB/T9074.4 M4x12	1	34	WE03040020012	Washer GB/T97.1 4	2
4	WE03010010062	Screw M5x20	4	35	WE02070010048	Spacer	2
5	WE70070130069	Cylinder	1	36	WE02050030229	Ignition Coil	1
6	WE03130010013	Spark Plug RCJ6Y	1	37	WE03020020054	Bolt GB/T9074.4 M4*20	2
7	WE02070010032	Cylinder Gasket	1	38	WE02050050213	Electrical Connections	1
8	WE02020020003	Piston Ring	2	39	WE02080030042	Rubber	1
9	WE02010020005	Piston	1	40	WE02070010162	Exhaust Gasket	1
10	WE02020150002	Stop Ring	2	41	WE02050010138	Exhaust	1
11	WE02020010004	Piston Pin	1	42	WE03050010008	Washer GB/T93 8	1
12	WE02020030017	Piston Pin Retainer	2	43	WE03040020018	Washer GB/T97.1 8	1
13	WE03090020018	Needle Bearing	1	44	WE03010010077	Bolt M5x55	2
14	WE02020120023	Crankshaft	1	45	WE02070010019	Side Gasket	1
15	WE03090010028	Bearing GB/T276 6001/P5	2	46	WE70030020016	Insulator	1
16	WE03100010009	Seal 12x22x7	2	47	WE03020020012	Bolt GB/T9074.4 M5*20	6
17	WE03060010002	Pin	4	48	WE02070010071	Carburettor Gasket	1
18	WE70070050038	Rear Crankcase	1	49	WE02050020101	Carburettor	1
19	WE02050100015	Starter Pawl	1	50	WE70080120007	Air Filter Housing with Choke	1
20	WE02050070090	Recoil Assembly	1	51	WE03020020044	Bolt GB/T9074.4 M5*55	2
21	WE03020020029	Screw GB/T9074.4 M4*16	5	52	WE02090010011	Air Filter	1
22	WE03070010001	Woodruff Key 3x3.7x12	1	53	WE70030040225	Air Filter Cover	1
23	WE02070010119	Crankcase Gasket	1	54	WE02110030079	Air Filter Screw	1
24	WE70070050039	Front Crankcase	1	55	WE02110020026	Fuel Tank Cap Assembly	1
25	WE03010010058	Bolt M5x25	4	56	WE61330010017	Fuel Inlet Pipe	1
26	WE02050030020	Flywheel	1	57	WE61330010018	Fuel Outlet Pipe	1
27	WE03030020003	Nut M8	1	58	WE02050120002	Fuel Filter	1
28	WE03040050052	Washer φ6*15*1.2	2	59	WE03020020027	Screw GB/T9074.4 M5*16	3
29	WE02050160002	Clutch Assembly	1	60	WE03040050022	Washer φ5*15*1	3
30	WE03040050042	Washer	2	61	WE70050030170	Fuel Tank	1
31	WE02020130001	Clutch Bolt	2				



PARTS DIAGRAM - WEPHT26 Machine

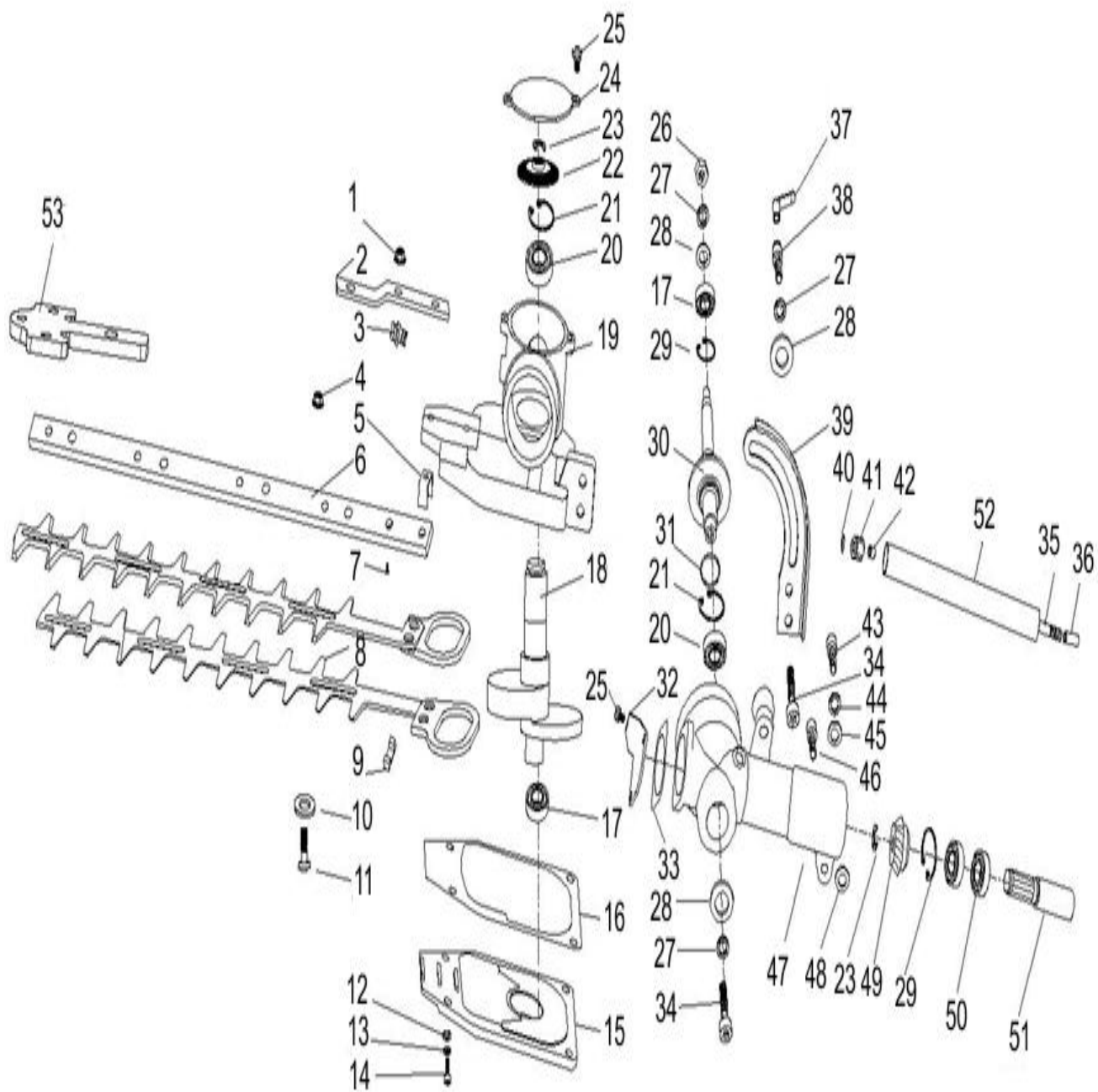

PARTS LIST - WEPHT26 Machine

Item No.	Part No.	Description	Qty	Item No.	Part No.	Description	Qty
1	WE03030060008	Nut M5	2	27	WE03050010013	Washer 6	3
2	WE02020160100	Blade Bracket	1	28	WE03040050050	Washer 6	3
3	WE03010110043	Grease Nipple	3	29	WE03120020007	Retaining Ring 22	2
4	WE03030060011	Nt M6	4	30	WE02020090014	Gear Shaft Assembly	1
5	WE02020160099	Clip	1	31	WE03110020004	Sealing Washer 41x3.5	1
6	WE02020070039	Blade Bar	1	32	WE02020160047	Gear Case Cover	1
7	WE03010110090	Screw M5x18	2	33	WE02070010103	Washer	1
8	WE02020070038	Blade Assembly	1	34	WE03010010038	Screw M6*14	3
9	WE02090030002	Felt	1	35	WE02020060021	Driveshaft	1
10	WE03040050068	Washer 6	4	36	WE02020160731	Joint B	1
11	WE03010110009	Bolt	4	37	WE70010050021	Angle Adjuster	1
12	WE03040020012	Washer 4	4	38	WE02020160304	Adjuster Screw	1
13	WE03050010006	Washer 4	4	39	WE02020070040	Angle Bracket	1
14	WE03010010027	Screw M4x12	4	40	WE02020150010	Washer	1
15	WE70070080058	Gear Case Cover	1	41	WE02080020006	Rubber Pipe	3
16	WE02070010274	Gear Case Gasket	1	42	WE02040010004	Oil Bearing	3
17	WE03090010005	Bearing 608-2RS	2	43	WE03010010011	Screw M5x25	1
18	WE02020090042	Blade Driver	1	44	WE03050010015	Washer 5	1
19	WE70070010013	Gear Case	1	45	WE03040020020	Washer 5	1
20	WE03090010015	Bearing 6000-2RS	2	46	WE03010010009	Screw M5x10	1
21	WE03120020002	Retaining Ring 26	2	47	WE70070010015	Gear Case	1
22	WE02020090016	Gear	1	48	WE03040050061	Washer 5	1
23	WE03120030005	Retaining Ring 6	2	49	WE02020090067	Gear	1
24	WE02110020009	Round Cover	1	50	WE03090010010	Bearing 6900-2Z/P5	2
25	WE03020010002	Screw M4x10	4	51	WE02020090138	Small Shaft	1
26	WE03030010004	Nut M6	1	52	WE02010010175	Shaft	1
				53	WE2020160891	Blade Tip Guard	1

INSTRUCTION MANUAL



EC DECLARATION OF CONFORMITY

We Handy Distribution Ltd - SN3 5HY (Importer) declare that the product:

Designation: Petrol Pole Hedge Trimmer

Model(s): WEPHT26

Type/Serial No. As per rating label on machine

Complies with the following directives:

Machinery Directive as last amended by EC Directive 2006/42/EC Annex -VII

Electromagnetic Directive as last amended by EC Directive 2014/30/EU

The conformity assessment procedure followed was in accordance with

EN ISO 11806-1:2011

EN ISO 10517/A1:2013

EN ISO 14982:2009

Measured Sound Pressure Level: $L_{PA} = 97\text{dB(A)}$

Measured Sound Power Level: $L_{WA} = 111\text{dB(A)}$

Notified Body:

TÜV SÜD Product Service GmbH

Addresses:

- 88 Heng Tong Road, Shanghai 200070, (P.R China)
- Zertifizierselle, Ridlerstraße 65, 80339 München, Germany

Authorised signatory and technical file holder

Date: 17/11/2015

Signature:

A handwritten signature in black ink, appearing to read "S Belcher", written over a horizontal line.

Name: Mr Simon Belcher

Position: Managing Director

Company: Handy Distribution Ltd

Address: Murdock Rd, Swindon, Wiltshire, SN3 5HY.





INSTRUCTION MANUAL

This Service Book is provided with your Webb, to help you look after your purchase to our recommendations and enable you to take advantage of the 2 year conditional manufacturer domestic warranty*.

* Commercial/Professional & Hire users receive a 90 day warranty

Present this service book to your authorised Webb repair dealer, whenever a service or a warranty appraisal is required.

The booklet is applicable to the following products, in the UK only:

- Ride On Lawn Tractors
- Petrol & Electric Cylinder Lawnmowers
- Petrol Rotary Lawnmowers
- Petrol Hand Held Range

Please register your machine using the following pages or at www.webblawnmowers.co.uk. By registering your machine, you agree to maintain the machine in accordance with the service schedules specified in this manual and services duly recorded. You may be asked to produce this booklet as proof of servicing in the event of a claim. Proof of purchase should also be kept as a reference.

Ensure you have the following information available from your machine product label. The two examples below can be found on your machine:



1. Model Number

2. Serial & Product Number

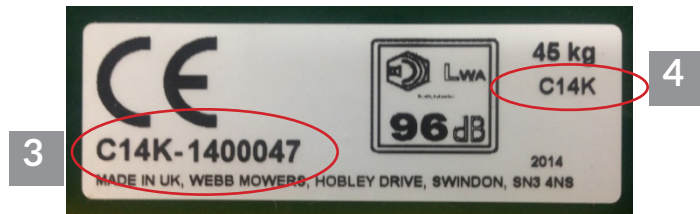

Cylinder Mowers Only

3. Serial Number

4. Model Number

Please complete using BLOCK CAPITALS. Sections marked* must be completed to validate Warranty.

SERVICE BOOK

1. Users Statement of Warranty

Each new machine is warranted against defective material or assembly of material under normal usage. The warranty applies to the original purchaser, is not transferable and covers faulty parts and the labour involved in replacing and repairing those parts, which are of original manufacture.

2. Period of Warranty

2 year conditional warranty from the original date of sale to the first domestic user.

90 days from the original date of sale to the professional/commercial or for hire user.

Engine warranty as per the engine manufacturer's warranty, which will be supplied with the machine.

90 days from the original date of sale for Replacement Spare Parts

All machines' must be serviced within the first 14 months from the original date of purchase, to qualify for a second year parts & labour warranty, details of the service must be recorded in the service record within this manual.

A reduced warranty period of 90 days applies to those items which are subject to normal wear and tear and in normal use, will need replacement or adjustment.

These items are chargeable after 90 days of ownership.

Filters
Tyres / Wheels
Drive chains and belts
Brake & clutch friction components
Control cable & starter cords
Fluids & lubricants
Spark plugs
Blades (Lawnmowers & Brushcutters)
Cutter bars (Hedgecutters)
Drive & clutch cable surfaces
Nylon Lines (Line Trimmers)
Carburettor cleaning
Bearings
Bushes
Electric cable
Grass collectors

3. Not covered by this warranty

(a) The warranty policy does not cover any depreciation or damages caused by ordinary wear, rusting or corrosion, lack of correct maintenance or operation, misuse, abuse, lack of transportation or accident.

(b) The warranty policy does not cover any costs necessary for the standard periodic maintenance services instructed by the operators manual, or service parts replacement which would include oil, filters, tyres, belts, brake linings, fuses, blades, seals and other service parts unless it can be proven that the item has evidence of faulty manufacture.

(c) The warranty policy will not cover failure or damage caused as a result of parts or accessories being modified without the written approval of GJ Handy & Co Ltd.

(d) The warranty policy will not cover the unit if non-genuine parts have been fitted and as a result damage has occurred to the unit.

(e) The warranty policy is non-transferable and is only applicable to the original purchaser.

4. Disclaimer

(a) This warranty is only a remedy for defect of products. GJ Handy & Co Ltd will never warranty in terms of the merchantability or the fitness for a particular purpose.

(b) No person is authorised to make any warranties, representations or promises, expressed or implied, on behalf of GJ Handy & Co Ltd, or to modify the terms conditions or limitation of this warranty policy in any way.

(c) Neither GJ Handy & Co Ltd nor any company affiliated with GJ Handy & Co Ltd shall be liable in any event or manner whatsoever for incidental or consequential damages or injuries, including, but not limited to, loss of crops, loss of profit, out of pocket expenses or profits, rental of substitute equipment or other commercial losses.



INSTRUCTION MANUAL

5. General

- (a) Most warrantable failures show up within the first few weeks of use. These failures are usually straightforward and warranty assessment is relatively easy.
- (b) Failures relating to cutter decks and belts need careful investigation, as the cause may not always be straightforward. Look for damage to blades and pulleys especially when the cutter belt or blade boss have snapped or cracked as this could be due to impact damage.
- (c) Customers should always refer to the operator/instruction manual when any disputed problem arises, you will find most areas covered within the manual.

Protecting your machine

Maintenance

Regular maintenance of your Webb machine is essential to ensure it operates, safely, efficiently and therefore reducing the environmental impact.

It is the owner's responsibility to ensure that their Webb machine is maintained at specific intervals. Any approved Webb service dealer can undertake a service, which are specialised in our products and will be aware of your particular machine and any technical updates which will save valuable time & money.

If you are using your machine in dry, dusty or high temperatures, you will need to service the machine more regularly.

Fuel

Due to ongoing efforts by fuel companies to reduce emissions, unleaded petrol will oxidize & deteriorate in storage overtime, leaving residue from detergent components.

Fuel deterioration problems may occur when petrol is stored for over 30 days. If you are planning to store fuel for over 30 days, we recommend you add Handy Parts Sure-Start fuel stabilizer to fresh fuel after purchasing. Sure-Start cannot reconstitute stale fuel.

Storage

When storing your machine for an extended period, we do recommend that you follow the instructions of engine instruction manual.

Always store the fuel in a clean, approved and sealed container. If the container is steel, ensure it is not corroded.

If the container is not filled to its recommended capacity, air can accelerate fuel deterioration.

Always store fuel away from direct sunlight, in a dark, cool environment.



SERVICE BOOK

Your servicing Webb approved dealer will stamp & date the below relevant sections, when the correct service actions have been completed.

PLEASE ENSURE THE SERVICE BOOK IS AVAILABLE FOR THE DEALER, DURING SERVICE WORK.

1st Service

This must be stamped by an approved service dealer to qualify for a free second year warranty.

12 Months

Date

24 Months

Date

36 Months

Date





INSTRUCTION MANUAL

48 Months

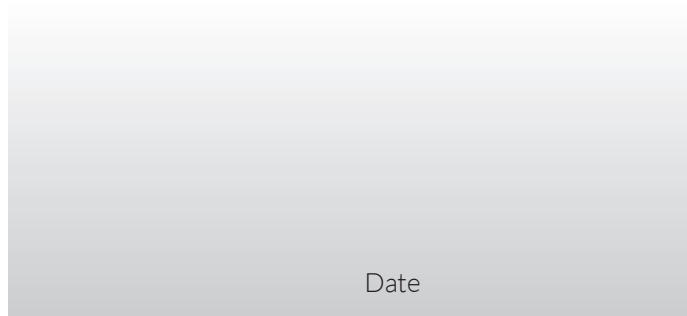

60 Months

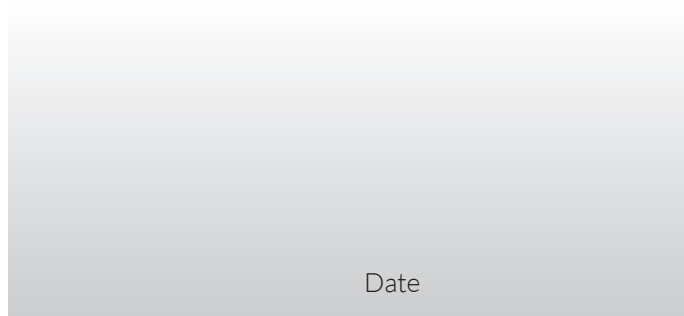

72 Months

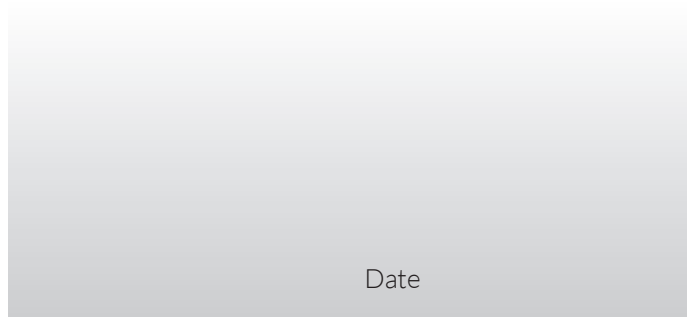

84 Months

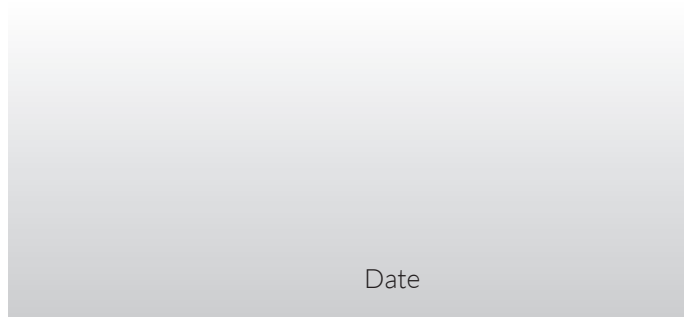

96 Months

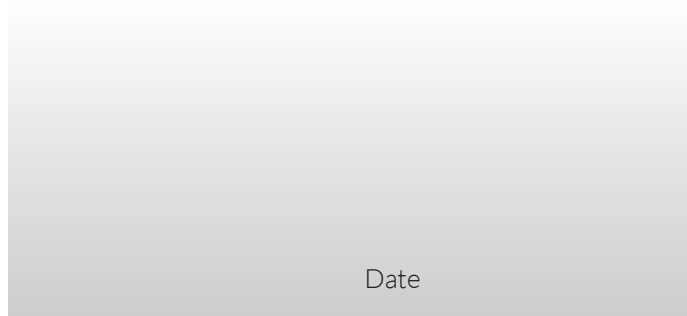

108 Months

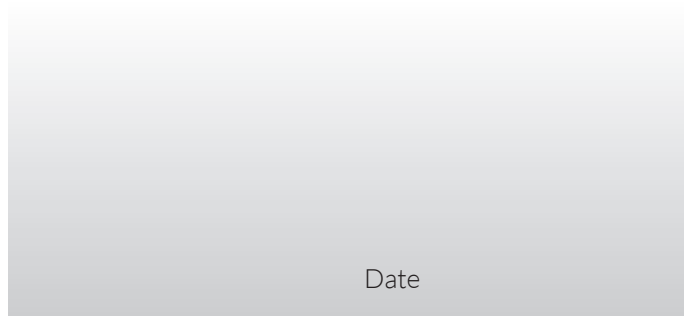

120 Months

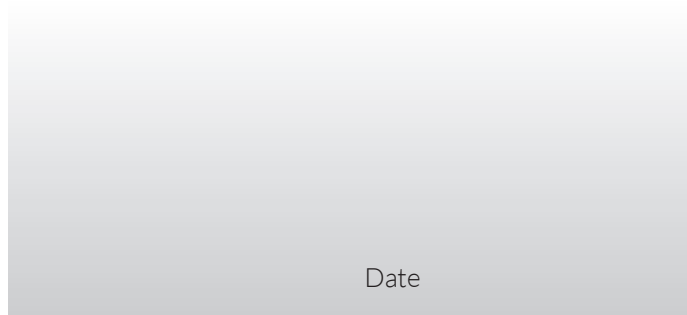

132 Months

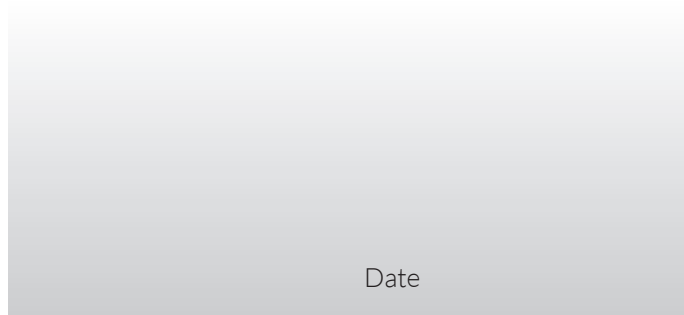

WARRANTY REGISTRATION

If you have registered online, this form is not necessary.
PLEASE POST THIS COPY TO THE ADDRESS OVERLEAF

Product Information (* Compulsory)

*Model No:	
*Product No:	
*Serial No:	
*Date of Purchase:	

Personal Information (* Compulsory)

*Title		*Forename		*Surname	
*House Number		*House Name			
*Address 1					
*Address 2					
*Town					
*County					
*Postcode					
Home Tel				Mobile Tel	
Email					

Age	18 to 25		26 to 35		36 to 45		46 to 60		61 to 80		81 & over	
-----	----------	--	----------	--	----------	--	----------	--	----------	--	-----------	--

*Dealer Stamp (Complete Address)



*Selling Retailer (If dealer stamp not available)

*Dealer Name	
*Dealer Address	

*Date of Purchase

*Usage	Domestic Use		Commercial/Professional/Hire Use	
--------	--------------	--	----------------------------------	--

Webb Lawnmowers privacy commitment to machine owners: Thank you for completing this form. The information supplied, helps us to improve the products & services we provide, including information that we believe is relevant to your and/or your machine. We value your trust by giving us this information about yourself and we are committed to protecting your privacy. From time to time Webb, its associated companies, authorised dealers or third parties working on our behalf may wish to contact you regarding our products, services, offers, technical improvements or just opinions, which may be used for marketing, research or analysis purposes.

If you DO NOT wish to be contacted by either of the following methods, please tick the relevant box POST TELEPHONE

If you would like us to contact you by Email, please tick this box

You may give Webb Lawnmowers notice in writing at any time that you no longer wish to receive direct marketing communications



Webb Lawnmowers
Murdock Road
Dorcan
Swindon
Wiltshire
SN3 5HY

