



# HOT TUB PRE-DELIVERY GUIDE



**SUPERIOR**  
WELLNESS

**YOUR JOURNEY TO ULTIMATE  
RELAXATION STARTS HERE.**



# Thank you for choosing **SUPERIOR WELLNESS**

---

This guide will help you prepare for the safe delivery and set up of your hot tub. You will find detailed important information on selecting the location, delivery access requirements, ground preparation and electrical regulations.

It is important that you take the time to read this guide before arranging delivery with our team.

**Failure to follow the procedures highlighted throughout this guide may result in damage to your hot tub and risks voiding your warranty.**

We hope that your hot tub or swim spa will bring you many years of fun and relaxation.

**Welcome to the Superior Wellness family.**







## **Preparation**

06 – **Before your delivery is booked**

08 – **Positioning**

10 – **Electrical requirements**

## **Access**

13 – **Access requirements**

**HIABs and cranes**

14 – **Swim spas**

15 – **Hot tubs**

16 – **Maintenance access**

## **Delivery**

18 – **Your pre-delivery checklist**

20 – **Your delivery day**

## Before your delivery is booked

---

Having a hot tub or swim spa delivered is an exciting time. We want to make sure you are fully prepared for the safe delivery, installation and long-term use of your hot tub.

When your hot tub is in stock or due to arrive shortly we will contact you to arrange a suitable delivery date. This will be approximately 14 days before delivery.

Please ensure you have met the requirements before we contact you to arrange a delivery date. When we telephone you to book your delivery date, you must confirm you have met each requirement:





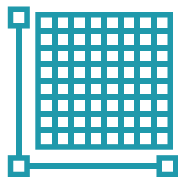

Agree the safe positioning of your hot tub at your property, ensuring full access of the hot tub is available once installed.  
(please see page 8)

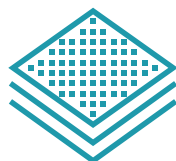

Arrange for a flat, level and solid base to be created for the positioning of your hot tub.  
(please see page 9)

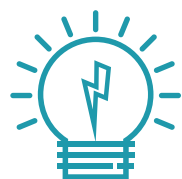

Ensure your electrical supply is fitted prior to your installation.  
(please see page 10)



Ensure you have measured your desired hot tub position with adequate space for your chosen hot tub.  
(please see page 13)



Send property access photos to our logistics team at [info@superiorwellness.co.uk](mailto:info@superiorwellness.co.uk)

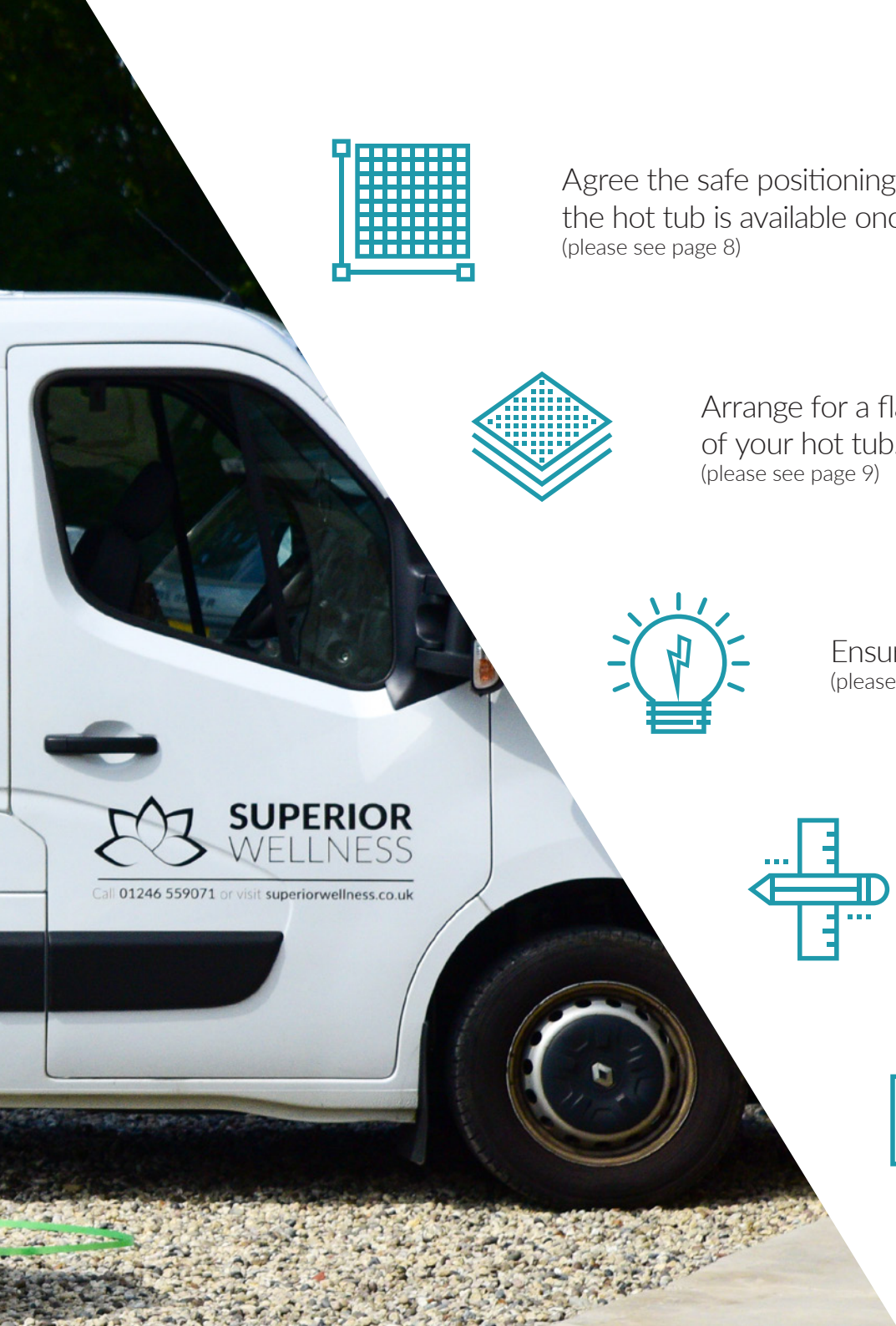



# Positioning

---

It is important you choose a suitable position and base for safety and to ensure your hot tub runs as efficiently as possible.

## Positioning your hot tub

**For safety and maintenance purposes, you should never position your hot tub near overhead cables or power lines.**

If you choose to position your hot tub near a slope, dip, trough or below ground level, please ensure there is adequate drainage in place for any excess ground water to run off. Please ensure the area in front of your hot tub is clear so that grass and debris are not transferred to the water upon entry.

You also need to ensure you leave enough space for a cover lifter to fall behind your hot tub. The average cover lifter requires 500mm to drop the cover down the back.

### TOP TIP:

When considering the position of your hot tub, think efficiency. If positioned high up on a hill, the water will be battling the wind and general outdoor weather conditions to stay at the desired temperature. To avoid this issue, consider placing your hot tub in a gazebo, or in a sheltered area.



## Constructing your base

**You need to prepare a solid, flat, and strong base that will remain stable for the life of your hot tub. An uneven base may cause your hot tub to run inefficiently, resulting in major faults.**

An ideal base material is solid **concrete** – soft surfaces such as grass, sand or pebbles are not suitable. Existing **patio slabs** and **block paving** may be used, but they must be flat, level and on a satisfactory sub-base such as concrete.

All newly constructed bases must be prepared in plenty of time prior to delivery to allow time for the concrete to fully set.

It is the responsibility of the customer to provide a suitable base that is **flat, level and solid** to prevent distortion from occurring. Any structural damage caused by an improper base or base failure may invalidate the manufacturing warranty. We advise all customers take into consideration a weight of at least 2,000kg.

**We do not advise you to position your hot tub with decking built around it or underground** as it can significantly impact future maintenance requirements. If you wish to do this, we advise you consult a structural engineer to ensure that your decking is capable of safely and adequately supporting the full weight of your hot tub when in use. The hot tub should be 200mm proud of the top of the decking to allow for the cover to clip onto the side.

### IMPORTANT:

Access is required to all sides of the hot tub and any obstacles blocking the access may result in our installation team having to reschedule\*. Our team will also require easy access to the service panel (positioned on the same side as the touch pad).\*Customers may be charged for revisits.

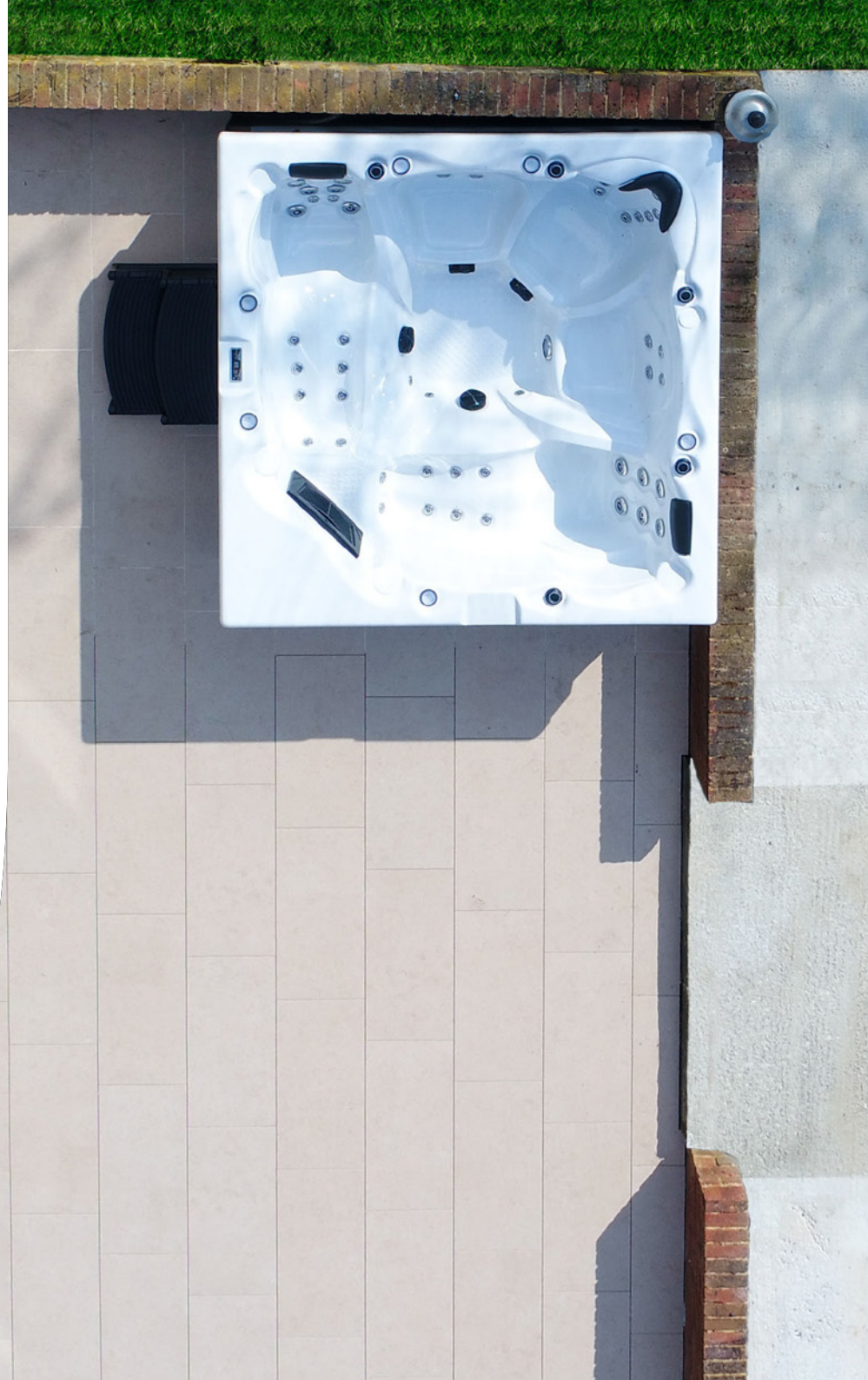

# Electrical requirements

## 13 amp supply

**Before installing a hot tub or swim spa, it is necessary to have your electrical supply fitted.**

You will require a 13, 32 or 40 amp supply (check with your supplier for the requirements for a swim spa) depending on which model you have purchased. Hot tubs or swim spas need to have their own circuit from the main distribution board; the supply should not be shared.

This guidance is for a 13 amp supply. Please view page 12 for a 32 & 40 amp supply.

**Before your hot tub arrives, please arrange for a qualified electrician to do the following for a 13 amp supply hot tub:**

Our 13 amp hot tubs do not come with a cable or plug. These will need to be sourced and supplied by you. The hot tub needs to have its own circuit from the main distribution board, the supply should not be shared. Please arrange for an electrician to do the following before the delivery day:

1. Install a 16 amp outdoor waterproof commando socket with RCD protection. Install an earth rod (If required).
2. Provide a 2.5mm 3 Core Flexible Cable and 16amp commando plug or a three pin plug with a minimum of 5m worth of cable left in a loop. Our delivery team are qualified to connect this cable to the inside of the hot tub. However, they will NOT hardwire your hot tub to the mains supply.

3. Ensure the outdoor socket is within 2-5m from the hot tub as the Flexible cable can't exceed more than 5m.

4. Our 13amp hot tubs potentially could be installed with a 13amp plug into a standard socket. This would need to be a dedicated supply from your main distribution board and we recommend you consult with your electrician to ensure this is suitable. However our recommendation is that you install the 16 amp commando socket to avoid any future problems.

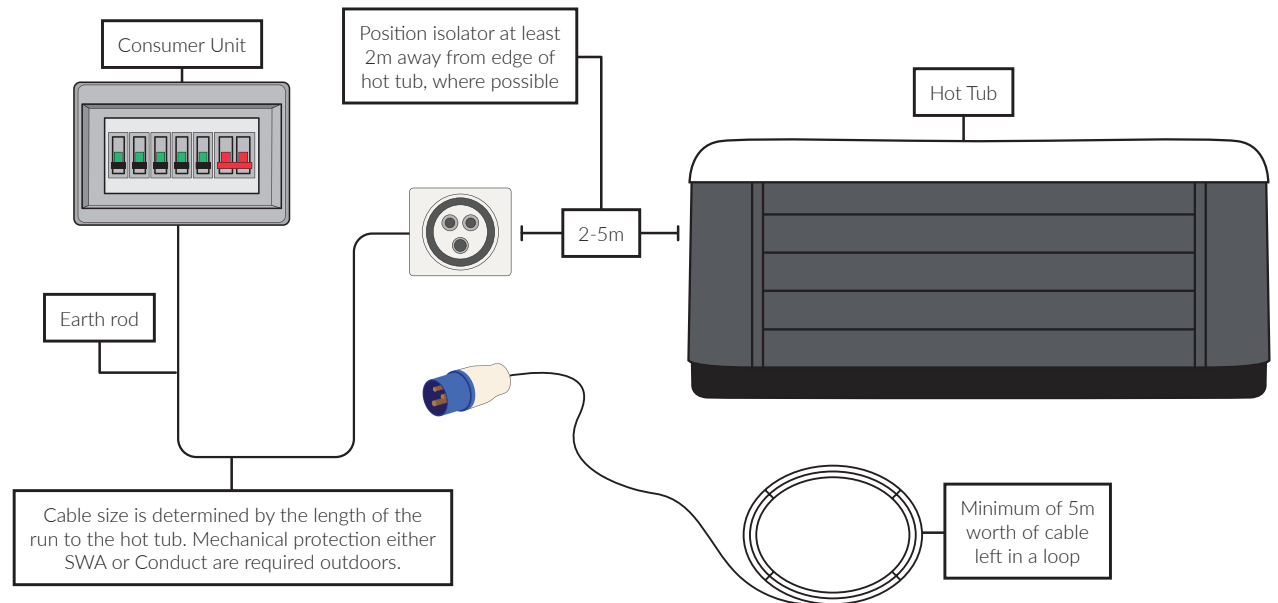
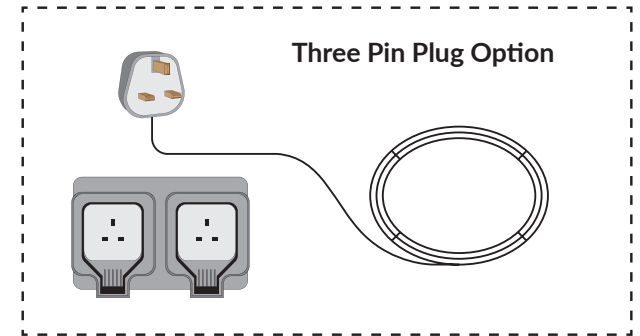





# PREPARATION



## 32 or 40 amp supply

**Before installing a hot tub or swim spa, it is necessary to have your electrical supply fitted.**

You will require a 13, 32 or 40 amp supply (check with your supplier for the requirements for a swim spa) depending on which model you have purchased. Hot tubs or swim spas need to have their own circuit from the main distribution board; the supply should not be shared.

The guidance below is for a 32 or 40 amp supply. Please view page 10 for a 13amp supply.

**Before your hot tub or swim spa arrives, please arrange for a qualified electrician to do the following for a 32 or 40 supply hot tub or swim spa:**

1. Add 32 or 40 amp Type C breaker to the consumer unit (See image 1)
2. From the main consumer unit, run a 6mm, 3 Core Armoured Cable to the Rotary Isolator Switch (See image 2)
3. Rotary Isolator Switch should be 2-5m from the hot tub. Install the earth rod (See image 3a)
4. Another 6mm, 3 Core Armoured Cable must be connected to the Rotary Isolator Switch with a minimum of 5m worth of cable left in a loop. Our delivery team are qualified to connect this cable to the inside of the hot tub. However, they will NOT hardwire your hot tub to the mains supply (See image 3b)
5. Your electrician should leave enough spare cable attached to the isolator to reach the side panel where the control panel is
6. A Part P certificate should be supplied by your electrician. This is to confirm that the electrical work is in line with government regulations. This paperwork must be kept on file and presented when requested.

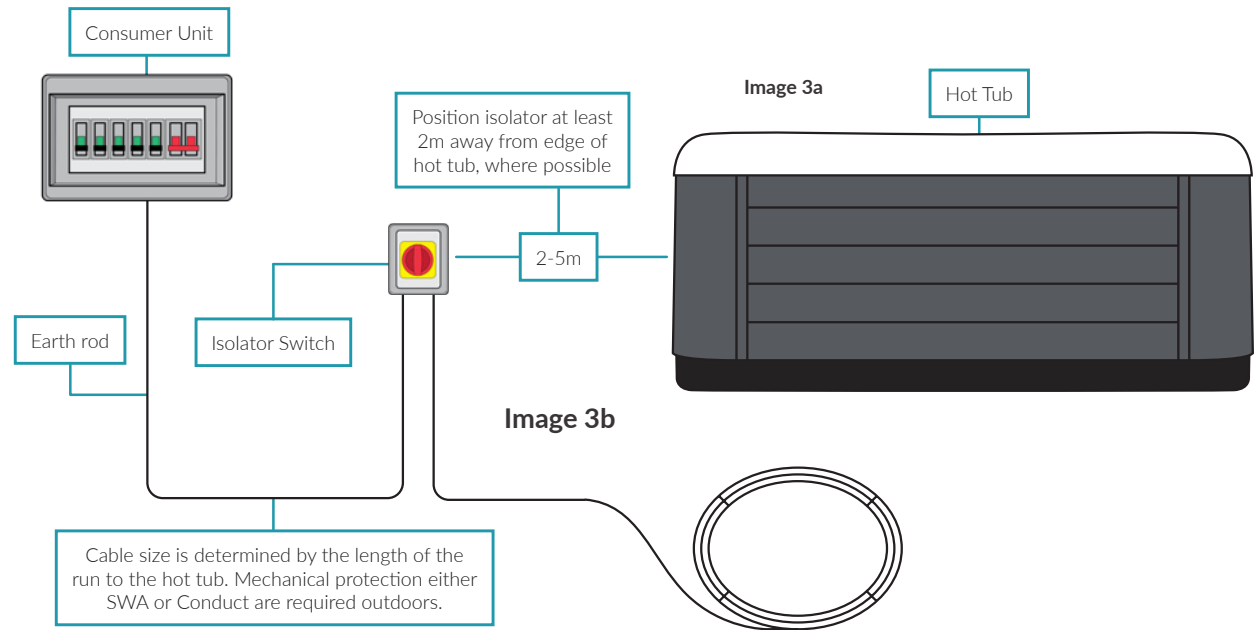

Image 1



Image 2





# PREPARATION









# HIABS & Cranes

---

## For Swim Spas

**Due to weight, swim spas will be delivered using a 'HIAB' crane, mounted on the delivery truck, or a larger separate crane.**

The maximum reach of our truck-mounted 'HIAB' crane is no more than 7 metres, but this will depend on where the swim spa is positioned in relation to the orientation of the truck. Trucks with HIAB cranes are usually quite large and so consideration needs to be made as to whether they will fit up a normal driveway.

Stand alone, truck-mounted cranes will have a much larger reach – approximately up to 44m. However, these cranes are often very wide and very heavy with many not being able to drive on a domestic driveway. If unsure, you should contact a local crane company who will carry out a site survey on your behalf.

Whilst swim spas can often be lifted without spreader bars, this is at the discretion of the crane company. It is the sole responsibility of the crane company to ensure that the swim spa is moved without damage, and it is your responsibility to ensure that they are suitably insured for any damage occurring to either the product or your property. Superior Wellness (or its employees) are not responsible for any damage to person(s) or owner(s) while the swim spa is in the air or while the crane is operating.

### IMPORTANT

A crane/HIAB must be arranged by the customer. It is the customer's responsibility to liaise with and pay the third party directly for this service.





## For Hot Tubs

If there are any slopes, retaining walls, steps or level differences that may cause problems with the installation of your hot tub, please contact us. Any extra resources required such as cranes or HIABs would be an additional charge and it is the customer's responsibility to arrange this through a third-party company.

Under special circumstances (usually where there is no clear or easy route), a crane can be used to position your hot tub. Please contact a local crane company to arrange this service if you think it may be necessary. The cost of the crane would be charged to you (the customer) and not included in our overall price.

**We would never lift a hot tub over a wall.**

### PLEASE NOTE:

Once in position, it is there to stay, therefore it is vital that the product is placed in its final position whilst the crane or HIAB truck is on site.

### IMPORTANT

Please bear in mind that the height of the hot tub will increase slightly when on the installation equipment (approximately 150 – 200mm).



# Maintenance access

---

A clearance of 600mm is required for all hot tubs in case of any future servicing or maintenance. If this is not practical, then the hot tub must be emptied of water and moved to allow access prior to any visits from Superior Wellness. This will be chargeable to the customer.

## Have you considered the following?

- What furniture will surround your hot tub, and could this cause an obstruction?
- If you decide to have decking built around your hot tub, have you left enough access for future maintenance?
- Have you prepared the base to allow room for the steps to sit on?

### IMPORTANT

If the hot tub needs to be positioned or moved for maintenance requirements using a crane/HIAB to obtain access, this will need to be arranged by the customer. It is the customer's responsibility to liaise with and pay the third party directly for this service.





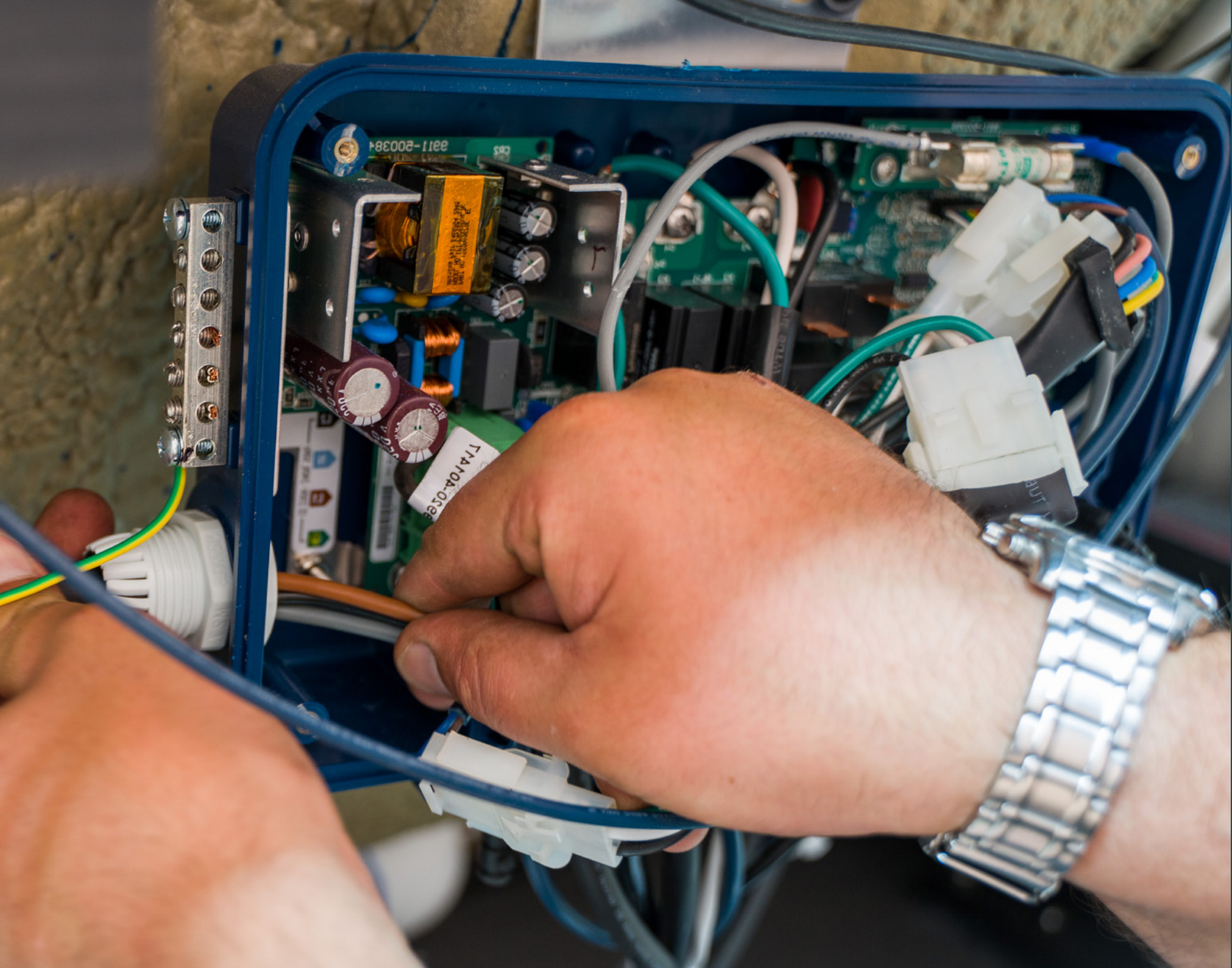

# Your pre-delivery checklist

To ensure you are prepared for delivery and installation, please complete the following checklist. If you have any questions or concerns please contact our Logistics team on **01246 559071** or email **info@superiorwellness.co.uk** and we will be happy to help.

## Access

- On delivery day, remove all vehicles on your drive to allow room for the delivery van
- Is your drive flat?
- If access is through/across a neighbouring property/land, do you have permission? **(Our installation team will not proceed without assurance that permission has been obtained prior to delivery)**

### ACTION FOR YOU:

Send the following access photos to **info@superiorwellness.co.uk**, quoting your order number, full name and postcode in the subject line:

- The drive, showing how to access the garden
- Any side passages
- The garden
- The final, desired position of the hot tub
- Video from road to end position

## Location

- I have the required measurements for both width (1m) and height (2.4m)
- I have allowed for a 500mm drop behind the back of my hot tub in case of using a cover lifter

### I have none of the below obstructions that reduce the minimum measurements:

- Window ledges, door handles, gas pipes, drainpipes, utility boxes, porches, gate posts, outdoor taps, garden pagoda or pergola, gazebos or archways
- If you have decking around the hot tub, the step up to the decking is lower than 30cm
- Will the decking support the hot tub weight when filled? And when occupied?
- A hose pipe can reach the hot tub and is ready for the hot tub to be filled



## Position

- There are fewer than three steps
- No walls/rockeries close by with a higher step than 30cm
- The base for the hot tub is flat, firm and solid
- Any obstacles such as plants and furniture have been removed
- No fences, hedge rows or bushes are blocking delivery access

### ACTION FOR YOU:

If you have answered **no** to any questions please, contact the Logistics team on **01246 559071**. Failure to do this might result in the delivery and installation having to be rescheduled.

## Electrical requirements

- 32 or 40 amp – add 32 or 40 amp breaker to the fuse box. Supply cable has been placed from isolator switch and ready to wire into the hot tub.
- 13 amp - add a 13 amp outdoor waterproof plug socket with RCD protection and ensure this is 2-5m from the hot tub
- Part P certificate has been supplied by electrician

**This must be completed before we deliver your hot tub.  
Failure to do so will mean that we cannot install your hot tub.**

### IMPORTANT

Delivery of your hot tub will NOT be booked until photos/videos showing access to the property and have been sent to our Logistics team and deemed as satisfactory. Please send all access photos and/or videos to: **info@superiorwellness.co.uk**. Return visits due to poor access, unsuitable grounds or obstacles, unsuitable electrical/water supply, etc. are chargeable to the customer.

# Your delivery day

---

On the morning of your planned delivery date, you will receive a text message with a specified time slot. If there are any issues with the timings provided, please advise a member of our team as soon as possible. One hour prior to our delivery team arriving at your property, you will receive a call to let you know the expected arrival time.

Once our delivery team arrive at your property, the installation of the hot tub will begin. Firstly, the delivery team will offload your hot tub from their vehicle, standing it onto what we call a 'spa sledge'. Once safely stood on the spa sledge, the team will glide the hot tub into the area you would like it to be positioned.

Once safely positioned, we will begin filling your hot tub, explaining the chemicals required to use it. Finally, a detailed explanation will be given as to when it is safe to start using the hot tub. There will also be the opportunity to ask our team any questions you may have.

## PLEASE NOTE:

A chemical starter kit will be provided, and a hot tub manual will be supplied for future reference.







## For Swim Spas

The customer will need to provide 12 bags of ice for the day of swim spa delivery. This is to be used when lowering the swim spa onto its base. The ice bags will be used as blocks to position the spa and in turn will allow the crane/HIAB straps to be safely removed.



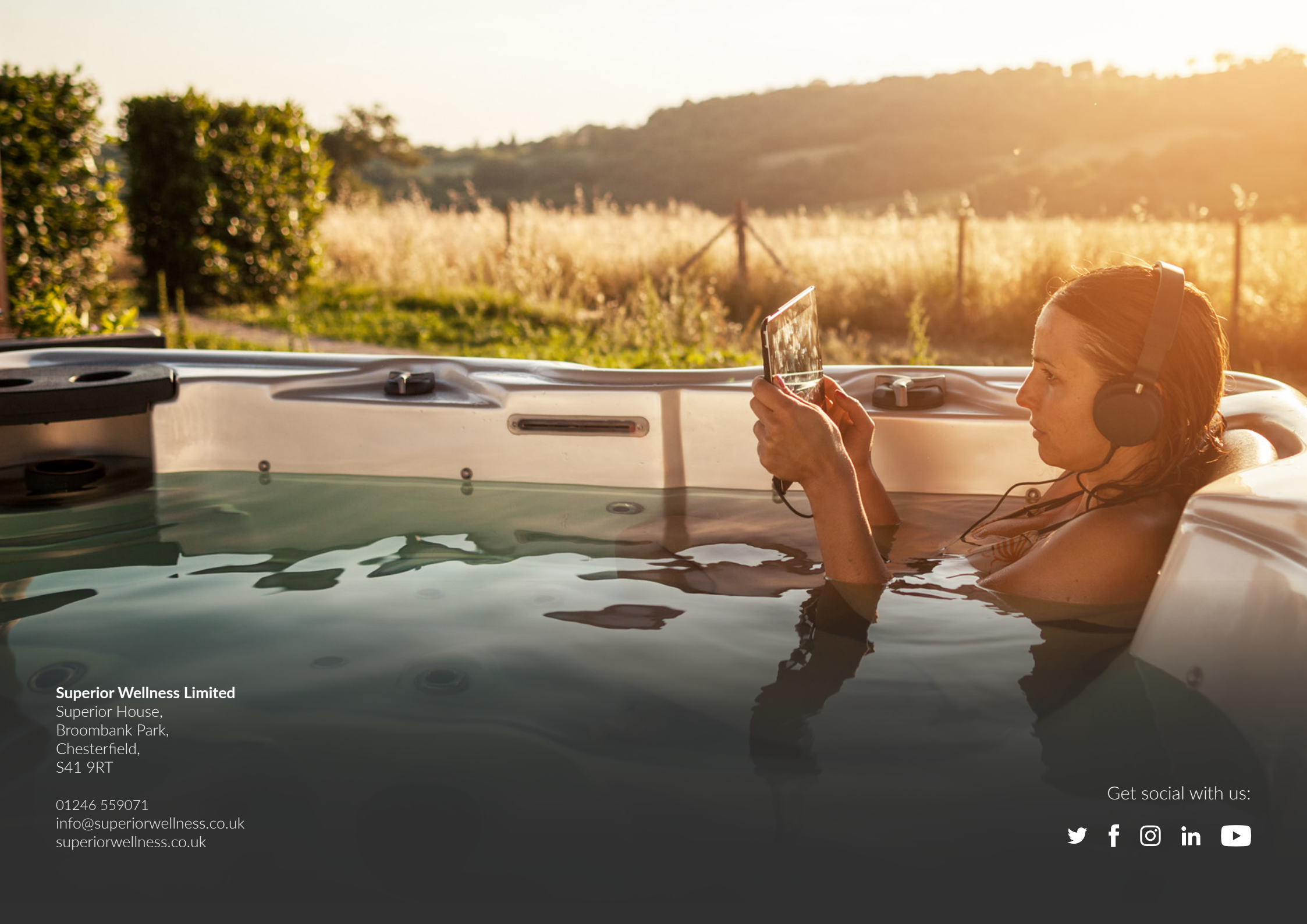

**Superior Wellness Limited**

Superior House,  
Broombank Park,  
Chesterfield,  
S41 9RT

01246 559071  
info@superiorwellness.co.uk  
superiorwellness.co.uk

Get social with us:

