



# Kube I water softener

## INSTALLATION INSTRUCTIONS



# Thank you for choosing a **Kube I** Water Softener by Kinetico to improve the quality of your water.

You will immediately begin to notice the numerous benefits of having quality water throughout your home and the benefits of having a **Kube** Water Softener.

Since 1970 Kinetico Incorporated has designed and manufactured products to improve the quality of your water. Kinetico offers a complete line of quality water systems to solve your water problems.

Pioneers in non-electric, demand operated water treatment, Kinetico continually sets the direction for the entire water quality industry. Our products are installed in hundreds of thousands of homes around the world.

Once you enjoy the benefits of your **Kube** Water Softener we are sure you will agree that Kinetico Water Systems are the world's finest.

For more information about Kinetico;

## **Kinetico UK Limited**

Bridge House, Park Gate Business Centre,  
Chandlers Way, Park Gate, Hampshire SO31 1FQ

**T:** 01489 566 970

**E:** [info@kinetico.co.uk](mailto:info@kinetico.co.uk)

**W:** [kinetico.co.uk](http://kinetico.co.uk)

# Contents

Contents of box	04
Safety information	05
Specifications	06
Typical installation	07
Installation instructions	08
Installation review and startup	10

# Contents of box

Please ensure you have all of the following items before proceeding with an installation.



1 x Water softener

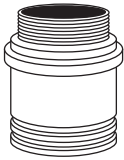

2 x 3/4" BSP  
in/out adaptor



4 x O-ring



1 x In/out  
retaining bracket



1 x Bracket  
retaining pin

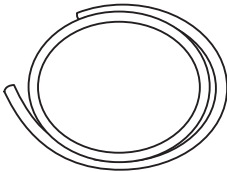

1 x 2m of 5/8"  
overflow tubing

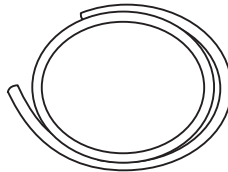

1 x 2m of 1/2"  
drain tubing

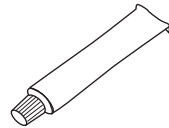

1 x 2cc silicone  
tube

# Safety information

Read all information carefully before installing and using the softener. Check WRAS Information and Guidance Note, no. 9-07-01 for regulatory advice.

- Kinetico recommends that a qualified installer or engineer performs the installation. Failure to install the system as instructed could invalidate the warranty.
- Do not install if the supply water pressure exceeds 6 bar (125 psi), unless a suitable pressure reducing valve has been installed on the water supply to the softener and set to 6 bar.
- Do not install the Kinetico softener in an area where the temperature can cause the unit to freeze. Freezing temperatures will damage the system.

## VERY IMPORTANT:

Where a cabinet overflow could cause damage, you must install the 5/8" O.D overflow tubing to the barbed fitting on the cabinet and run to a suitable outlet that is visible and capable of taking the overflow (ie. through the outside wall). Make sure the outlet is not higher than the barbed fitting.

- When installing a plastic component on a copper pipe in line, earth continuity straps must be placed ACROSS the component being fitted to ensure that the earth continuity is never broken.
- A Kinetico installation kit includes a by-pass assembly which conforms to BS14743 and enables the softener to be isolated from the water service lines for maintenance and service. This also maintains the water supply when the system is disconnected.
- These systems are not intended to be used for treating water that is microbiologically unsafe or water that has an unknown quality without adequate disinfection before or after the system.

## IMPORTANT:

Refer to the plumbing schematic in Figure 1 before beginning installation.



WRAS approval for the Kube I applies to cold water (max 23° C) installs only.

# Specifications

## Kube I Water Softener

Hardness Level mg/L	100	125	150	200	250	350	525
Litres between regenerations	1,358	1,083	905	689	531	394	256

Maximum Hardness	525 mg/L
Cabinet Dimensions @ base	H 492mm x D 425mm x W 235mm
Salt used per regeneration	0.27kg
Water used per regeneration	25 litres
Regeneration Time	12 minutes
Flow Rate @ 1 bar pessure drop	30 litres per minute
Flow Rate @ 2 bar pessure drop	40 litres per minute
Pipe connections - in/out	3/4" BSP male
Drain	Drain Kit and hose suitable for 32mm & 40mm. Waste Pipe supplied.
Overflow	5/8" OD Barb - Hose supplied
Minimum/Maximum Operating Temperature	2° - 23°C
Minimum pressure	1.5 bar (dynamic)
Maximum pressure	8 bar*

\*Recommend PRV fitted if above 6 bar.

# Typical installation

Your installation may vary.

1. A non-return valve (included in the by-pass set) is required on the mains water supply to the softener.
2. Fit a pressure regulating valve, where water supply pressure exceeds 6 bar on the mains water supply to the softener.
3. Plumb a drain line from the softener to a waste pipe through an appropriate air gap compliant with water regulations.
4. Consult WRAS Information and Guidance Note, no. 9-07-01 for regulatory advice.

**FIGURE 1:**

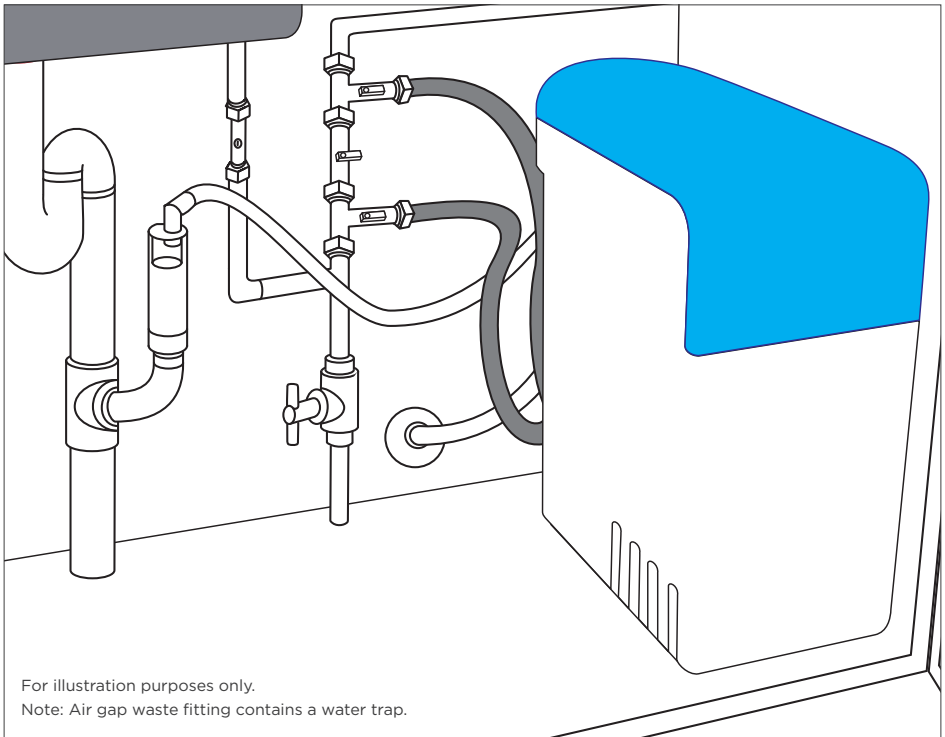

# Installation instructions

## 1 Locate:

Determine location to install equipment. Make sure that the unit will be on a flat surface. If the unit is sited in a warm environment or next to a heat-generating appliance, you may experience salt build up on the inside of the cabinet. This may need to be periodically cleaned. Alternatively, site the unit in cooler, ventilated position.

## 2 Test pressure:

Test incoming pressure to the unit. A pressure reducing valve is recommended if the pressure is above 6 bar.

## 3 Install:

Plumb pipe work as necessary to accommodate a by-pass valve set, see **Figure 1**.

### CAUTION:

Do not solder any fittings whilst connected to the unit adaptors. Excessive heat may result in damage to the plastic and rubber parts. The materials used in the soldering process may attack certain types of plastics. Care should be taken during the installation process to ensure that solder and flux do not come in contact with media tank, control module and related plastic components.

### NOTE:

**Verify installation complies with regulations before continuing.**

## 4 Flush:

After all the plumbing has been completed, but before connecting the water softener, flush the pipe work allowing water to rinse out any residual debris.

## 5 Attach drain and overflow tubing:

Insert 1/2" tubing into the drain elbow, routing the tubing around the control valve exiting the softener in the aperture below the in/out connectors, see **Figure 2**.

Make sure the tubing is inserted 18mm into fitting as shown in **Figure 3**.

Run the drain line to the discharge point then attach 5/8" overflow tubing to barbed overflow connection at rear of cabinet and route to overflow outlet.



**NOTE:**

The drain tubing should be run no more than 2 metres vertically and 9 metres horizontally, before connecting to the main drain. Make sure there are no obstructions or kinks in drain tubing before connecting to softener.

**FIGURE 2:**

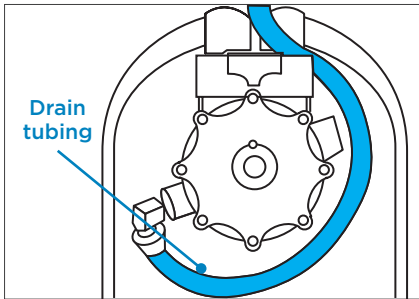

Colour of tubing for illustration purposes only.

**FIGURE 3:**

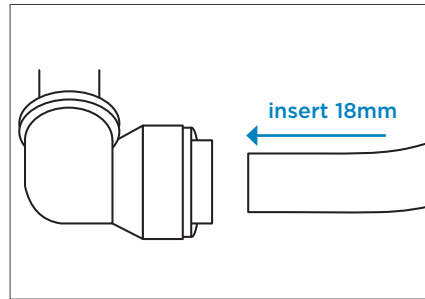

**6 Set regeneration frequency:**

See **Figure 4** for top view of softener valve. Determine the supply water hardness value in ppm or mg/L by using a test kit or by contacting your water supplier. Put a cross headed screw driver into the recess on the top of the unit and whilst keeping the screw driver pushed down, turn at least one full rotation to reset the metering system.

Locate value on the meter disc, push down and turn the hardness adjustment knob so that the hardness value is positioned opposite the alignment arrow. If the dial does not move repeat the resetting process.

**7 Fit the adapters:**

Fit 2 O-rings to each in/out adaptor then lubricate with supplied silicone grease. Connect the inlet/outlet adapters to the supply and return hoses remembering to use screened washers. Install adapters into control valve in/out ports, ensuring that they are fitted into the correct ports (see flow arrows on valve for reference). Attach the retaining bracket and pin to the control valve.

# Installation review and startup

## 1 Test pressure:

Test incoming pressure to the unit and adjust pressure reducing valve if the pressure is still above 6 bar.

## 2 Secure drain line:

Make sure the drain line is secure, using an airgap that is compliant.

## 3 Main inlet valve:

With the by-pass in position (inlet closed, outlet closed, by-pass open), open the main inlet valve slowly and check for leaks in the plumbing.

## 4 Finish system set up:

If cabinet does not fill up with water, add 6 litres of water to the Kube I cabinet. Add a quality grade of block or tablet salt.

## 5 Start a manual regeneration:

Using a #2 Phillips screwdriver, push down firmly on the actuator and slowly turn clockwise, listening for four clicks to start the regeneration. At this point you should hear water begin to run through the system. If you do not hear water running through the system, the disc may not have been advanced far enough, continue to turn.

After 12 minutes the regeneration will be complete and the softener is ready for service.

## 6 Salt Options:

You have the option of using block or tablet salt.

### **IMPORTANT:**

**On no account should granular salt be used in any Kineticico Water Softener**

## 7 Leave in service:

Open outlet valve and close bypass.

**FIGURE 4:**

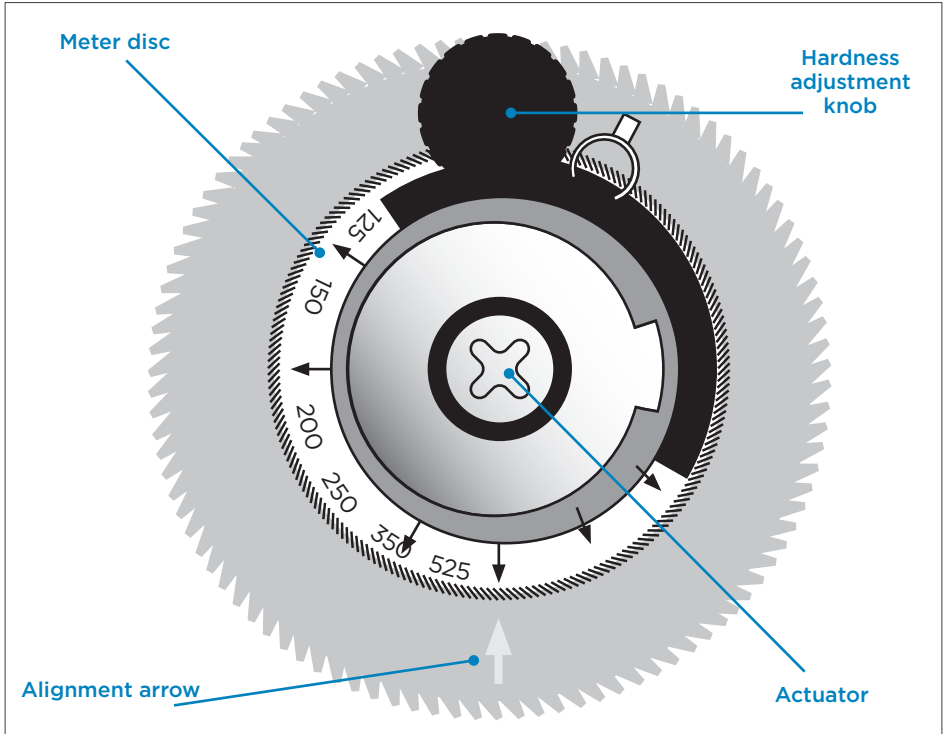



**Kinetico UK Limited**

Bridge House, Park Gate Business Centre,  
Chandlers Way, Park Gate, Hampshire SO31 1FQ

**T:** 01489 566 970

**E:** [info@kinetico.co.uk](mailto:info@kinetico.co.uk)

**W:** [kinetico.co.uk](http://kinetico.co.uk)

© 2018 Kinetico UK Limited

Kinetico reserves the right to amend details or specifications without notice. All trademarks are registered to Kinetico Incorporated, Newbury, Ohio.