

**5 PIECE WOVEN SEATING SET WITH FIRE  
ITM. / ART. 361115**

**IMPORTANT, RETAIN FOR FUTURE REFERENCE: READ CAREFULLY**

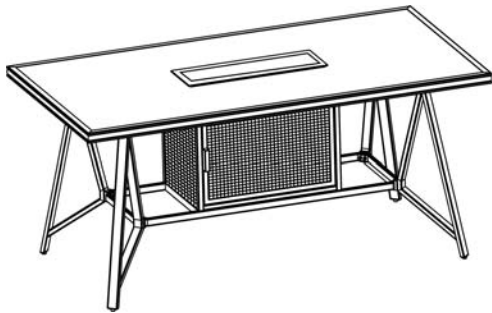

0063-21

Model No.  
ARK13600

**Installer: Leave these instructions with consumer.**  
**Consumer: Keep these instructions for future reference.**

**WARNING: If the information in this manual is not followed exactly, a fire or explosion may result causing property damage, personal injury or loss of life.**

- Do not store or use gasoline or other flammable vapors and liquids in the vicinity of this or any other appliance.
- **WHAT TO DO IF YOU SMELL GAS.**
- Do not try to light any appliance.
- Do not touch any electrical switch; do not use any phone in your building.
- Immediately call your gas supplier from a neighbor's phone. Follow the gas supplier's instructions.
- If you cannot reach your gas supplier, call the fire department.
- Installation and service must be performed by a qualified installer, service agency or the gas supplier equipment.

**WARNING:** It is UNSAFE to use this product for cooking!



Questions, Problems, Missing Parts? Before returning to your retailer, call our customer service department in the US and Canada at 1-888-383-1932, Monday-Friday, 9 a.m. – 5 p.m Eastern Time. English and French, or you may Email [customerservice@agio-usa.com](mailto:customerservice@agio-usa.com)  
International Regions: Please visit <http://www.agio-usa.com/service-center/costco-international>

**IMPORTANT, RETAIN FOR FUTURE REFERENCE: READ CAREFULLY**

**WARNING:** Before placing the burner cover on, make sure the firepit has been shut off and the burner has completely cooled down.

Conditions for use of the product: This product is for outdoor use only. Not for commercial use.

**WARNING:** A parasol shall not be placed on or shall be used with a separate base.

**WARNING:** For Outdoor Use Only

**WARNING: Do Not Burn Wood or any other materials in this firepit.**

FOR USE WITH 5KG PATIO GAS PROPANE CYLINDER (NOT SUPPLIED) WITH CLIP-ON CONNECTION OR USE WITH NATURAL GAS AFTER CONVERSION KIT (SUPPLIED) IS INSTALLED.

**WARNING:** Improper installation, adjustment alteration, service, or maintenance can cause injury or property damage. Read the installation, operating, and maintenance instructions thoroughly before installing or servicing this equipment. This appliance must be installed and the gas cylinder stored in accordance with the regulations in force.

**WARNING:** USE FACTORY APPROVED REPLACEMENT PARTS AND ACCESSORIES ONLY. USE OF UNAPPROVED PARTS OR ACCESSORIES CAN VOID THE WARRANTY ON THIS PRODUCT AND RESULT IN A HAZARDOUS CONDITION. PLEASE CONTACT US FOR INFORMATION REGARDING REPLACEMENT HOSES, THERMOCOUPLES, ELECTRODES, IGNITION MODULES, LAVA ROCKS, LOGS, ETC.

# TABLE OF CONTENTS

|   |       |
|---|-------|
| Important Safety Information .....        | 3     |
| Important Information about Propane ..... | 4     |
| Specification.....                        | 4     |
| Parts Identification List .....           | 5-6   |
| Installation.....                         | 7-9   |
| Natural Gas Conversion.....               | 10-11 |
| Batteries.....                            | 11    |
| Maintenance .....                         | 12    |
| Lighting Instructions .....               | 12    |
| Burner Cover Assembly .....               | 12    |
| Troubleshooting Guide.....                | 13    |

# IMPORTANT SAFETY INFORMATION

The appliance area must be kept clear and free from combustible materials, gasoline, and other flammable vapors and liquids.

Do not use this appliance if any part has been under water. Immediately call a qualified service technician to inspect the appliance and to replace any part of the control system and any gas control which has been under water.

**Children and adults should be alerted to the hazards of high surface temperatures and kept at a safe distance to avoid burns or clothing ignition.**

**Young children should be carefully supervised when they are anywhere near the appliance.**

**Clothing or other flammable material should not be hung from the appliance, or placed on or near the appliance.**

**Any screen or guard removed for servicing an appliance must be replaced prior to operating the appliance.**

**Installation and repair should be done by a qualified service person. The appliance should be inspected before use and at least annually by a professional service person. More frequent cleaning may be required as necessary. It is imperative that the control compartments, burners and circulating air passageways of the appliance be kept clean.**

Do NOT burn solid fuels in this gas fireplace.

Do NOT ignite the burner before pouring all of the burner media (fire glass) into the burner pan. The media must be evenly distributed over the burner.

During initial firing of firepit, please stay away from the firepit for 20 minutes as fire media (fire ice) may pop and hit someone on the face or eyes.

Do NOT ignite or use the firepit if the burner media (fire glass) are wet. Ensure the burner media are completely dry before igniting as intense heat could cause the media to crack and pop.

It is UNSAFE to use this product for cooking!

**CAUTION:** The propane gas pressure regulator provided with this appliance must be used. This regulator is set for an outlet pressure of 37 mbar.

This outdoor gas appliance is not intended to be installed in or on recreational vehicles and/or boats.

Before each use of this gas appliance, open the LP (Liquid Propane) Tank Drawer and inspect the LP Hose. If there is evidence of excessive abrasion or wear, or the hose is cut, it must be replaced prior to the gas appliance being put into operation. Use only the replacement hose assembly specified in this manual. Inspect the burner before each use of the appliance. The burner must be replaced prior to the appliance being put into operation if it is evident that the burner is damaged. Use only the burner listed in these instructions.

Keep the fuel supply hose away from any heated surfaces. Check the tubing or the flexible hose (at least once per month and each time the cylinder is changed). If it shows signs of cracking, splitting or other deterioration it shall be exchanged for new hose of the same length and of the equivalent quality; The tubing or the flexible hose must be changed within the prescribed intervals Shut off the valve at the gas cylinder or the regulator before moving the appliance Be careful, accessible parts may be very hot. Keep away from young children

Do Not move the appliance during use.

# IMPORTANT SAFETY INFORMATION ABOUT PROPANE (LP) GAS

- The cylinder supply system must be arranged for vapor withdrawal.
- This appliance shall be used only outdoors in a well-ventilated space and shall not be used in a building, garage, or any other enclosed space.
- When this appliance is not in use, the gas must be turned off at the supply cylinder.
- Storage of this appliance indoors is permissible only if the cylinder is disconnected and removed from the appliance.
- Cylinders must be stored outdoors in a well-ventilated area out of the reach of children .Disconnected cylinders must have protective caps installed and must not be stored in a building, garage, or any other enclosed areas.
- Change the gas cylinder in an amply ventilated area, away from any ignition source (candle, cigarettes, other flame producing appliances).
- Check that the regulator seal is correctly fitted and able to fulfill its function.
- Do not obstruct the ventilation holes of the cylinder housing.
- Use only the type of gas and the type of cylinder specified by the manufacturer.
- In case of violent wind particular attention must be taken against tilting of the appliance.

This appliance is for use only with a 5KG Patio Gas Cylinder unless converted for use with Natural Gas with the provided gas conversion kit. The cylinder must be equipped for a clip-on regulator. See Figure 1.

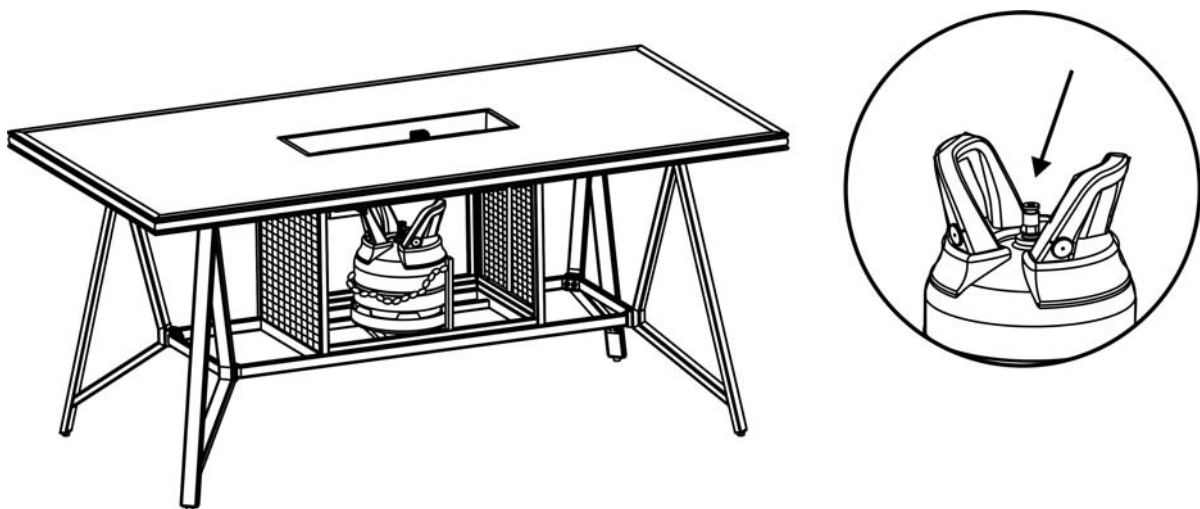

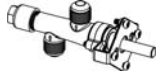









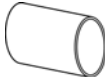



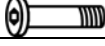



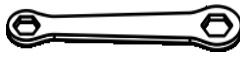



Figure 1

## SPECIFICATIONS

|                                    |                        |                                 |
|------------------------------------|------------------------|---------------------------------|
| Appliance Category II2H3P          | Appliance Type A       | Country GB                      |
| INPUT                              | <u>High Fire</u>       | <u>Low Fire</u>                 |
| Propane(G31)                       | 9.0 kW 643 gr per hr.  | 6.0 kW 429 gr per hr.           |
| Natural Gas (G20)                  | 9.0 kW                 | 3.5 kW                          |
| Propane Regulator Pressure         | 37 mbar                | 1.50 mm Injector, Marking: 1.50 |
| Natural Gas Inlet Pressure         | 20 mbar                | 2.15 mm Injector, Marking: 2.15 |
| Clearances to combustible surfaces | Sides 24 in / 60.96 cm | Top: 72 in / 182.88 cm          |

# PARTS IDENTIFICATION LIST

|   | PART  | DESCRIPTION                   | PART#  | QTY |
|---|---|-------------------------------|--------|-----|
| A |    | CONTROL KNOB                  | FP2329 | 1   |
| B |    | GAS VALVE                     | FP3703 | 1   |
| C |    | THERMOCOUPLE                  | FP2331 | 1   |
| D |    | FLEX CONNECTOR                | FP2332 | 1   |
| E |    | ELECTRODE                     | FP2333 | 1   |
| F |    | IGNITION MODULE               | FP2334 | 1   |
| G |    | CHAIN                         | FP1736 | 1   |
| H |    | PROPANE ORIFICE               | FP2510 | 1   |
| I |    | LP REGULATOR HOSE             | FP2025 | 1   |
| J |  | FOOT CAPS                     | FC0759 | 4   |
| K |  | "AA" BATTERY                  | HW0905 | 1   |
| L |  | AIR SHUTTER                   | FP1922 | 1   |
| M |  | FIRE ICE (TOTAL:7KG)          | FP1644 | 1   |
| N |  | NATURAL GAS ORIFICE           | FP2512 | 1   |
| O |  | M4 SCREW                      | HW0898 | 2   |
| P |  | 1/4" X 20 MM SCREW            | HW0036 | 12  |
| Q |  | 1/4" X 50 MM SCREW            | HW0090 | 4   |
| R |  | 1/4" NUT                      | HW0014 | 8   |
| S |  | Ø6.5 X 1.0 MM WASHER          | HW0004 | 16  |
| T |  | Ø20 X Ø6.5 X 2.0 MM<br>WASHER | HW0594 | 8   |
| U |  | HEX BOLT DRIVER               | HW0252 | 1   |
| V |  | HEX WRENCH                    | HW0009 | 1   |

|    |   |                               |        |   |
|----|---|-------------------------------|--------|---|
| W  |    | CROSS POINT<br>SCREWDRIVER    | HW0900 | 1 |
| X  |    | FIREPIT TABLE TOP             | FP3716 | 1 |
| Y  |    | FIREPIT BASE                  | FP3717 | 1 |
| Z  |    | FIREPIT TABLE LEG             | FP3718 | 4 |
| AA |    | LEG SUPPORT                   | FP3719 | 2 |
| BB |    | LEG CONNECTOR<br>BRACKET      | FP3720 | 1 |
| CC |    | BURNER COVER                  | FP3721 | 1 |
| DD |    | FIREPAN/BURNER<br>ASSEMBLY    | FP3722 | 1 |
| EE |    | BURNER PAN PROTECTIVE<br>RING | FP3723 | 1 |
| FF |  | ORIFICE HOLDER                | FP3573 | 1 |

# INSTALLATION

1. Carefully unpack all items from the box. Place the base in the final position. There must be a minimum of 60.96 cm / 24 inches of clearance from the side of the table top to any combustible walls.

2. Attach a leg support to two table legs by using two 1/4"x20 mm bolts and Ø6.5x1.0 mm washers as shown in Figure 2. Guide the bolts through the holes in the leg support, into the pre-drilled holes in the legs. Hand tighten only 2-3 turns. Repeat for the other legs and leg support.

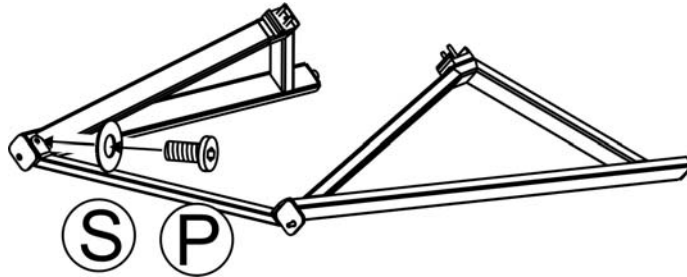

Figure 2

3. Place the firepit tabletop upside down on a flat, non-abrasive surface. Attach the firepit base to the table top by using four 1/4"x20 mm bolts and Ø20xØ6.5x2.0mm washers as shown in Figure 3. Guide the bolts through the holes in the complete base into the pre-drilled holes in the table top. Hand tighten only 2-3 turns.

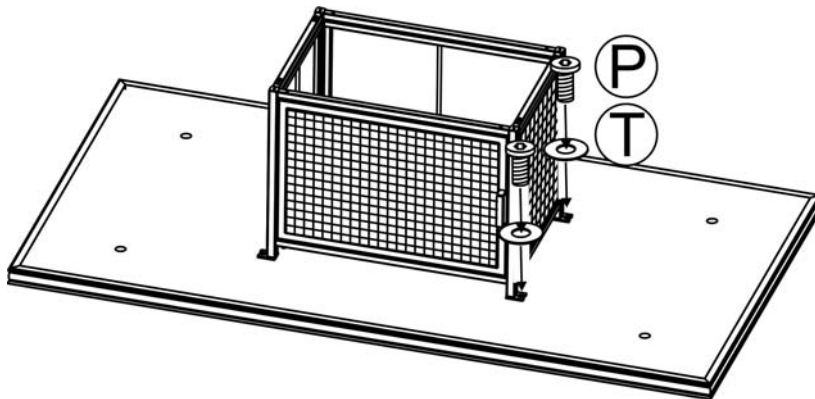

Figure 3

4. Attach the leg connector bracket to the firepit base by using four 1/4"x50 mm bolts and Ø6.5x1.0 mm washers as shown in Figure 4. Guide the bolts through the holes in the complete base into the pre-drilled holes in the table top. Hand tighten only 2-3 turns.

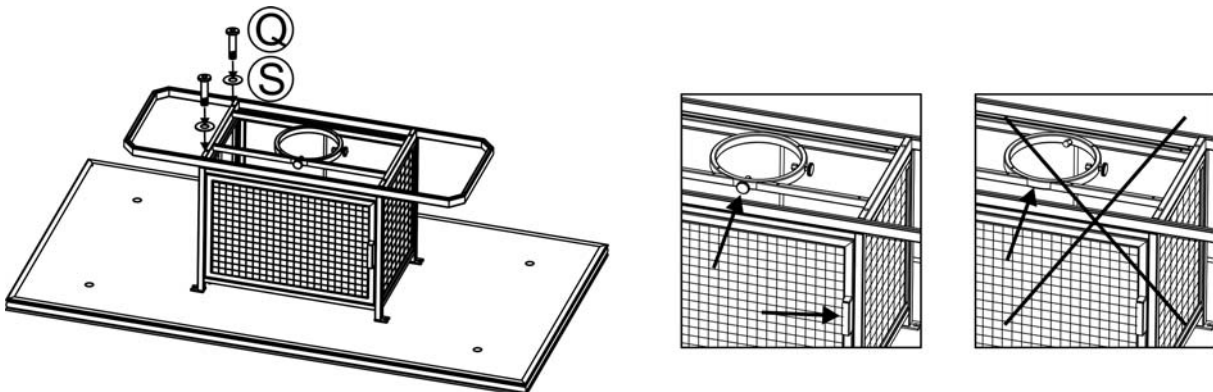

Figure 4

5. Attach the complete leg to the firepit tabletop by using two 1/4"x20 mm bolts and Ø20xØ6.5x2.0mm washers as shown in Figure 5a. Hand tighten only 2-3 turns. Attach the complete leg to the leg connector bracket by using two 1/4"nuts and Ø6.5x1.0 mm washers as shown in Figure 5b. Hand tighten only 2-3 turns. Repeat for the other complete leg.

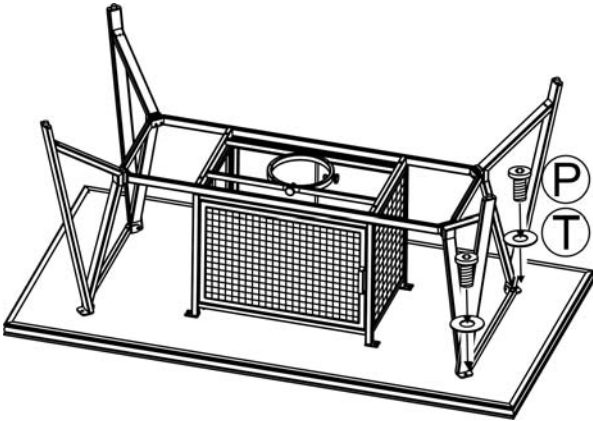

Figure 5a

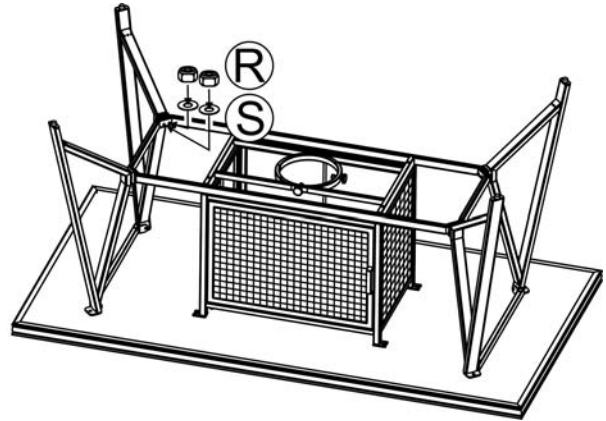

Figure 5b

6. After making any necessary adjustments to the alignment of the firepit, use the hex bolt driver to tighten all bolts. Repeat until all bolts are tight. Do not over tighten. Over tightening may strip bolts. With the help of another person, turn the table in the upright position.

7. Place the burner pan protective ring into the firepan/burner assembly as shown in Figure 6. Align the holes in the burner pan protective ring with the pre-drilled holes on the firepan/burner assembly. Secure the burner pan protective ring to the firepan/burner assembly by using the M4 screws as shown in Figure 6.

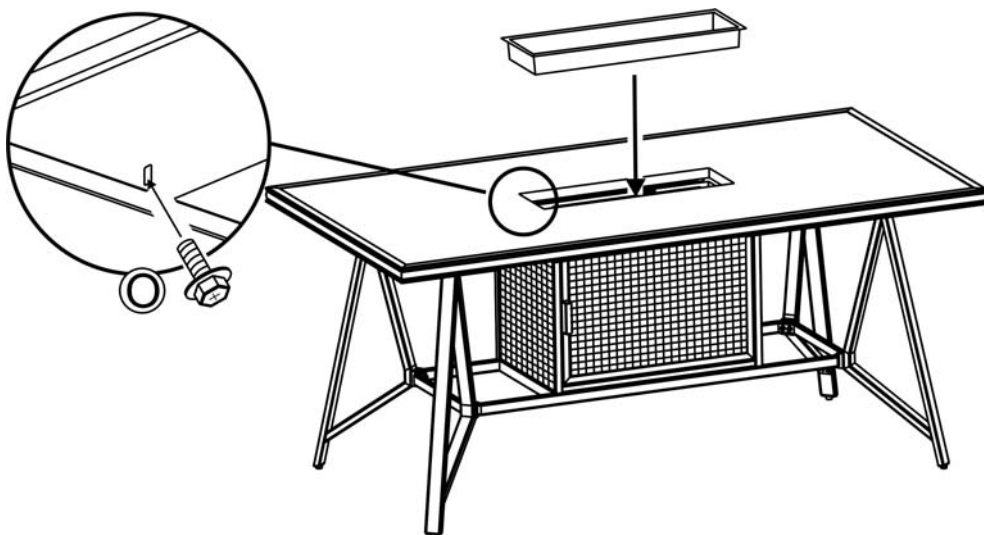

Figure 6



8. Pour ALL of the provided media (fire ice) into the burner pan. Burner MUST be completely covered to ensure the appliance functions properly and safely. Remove any fire ice on top of the ignition well. See Figure 7.

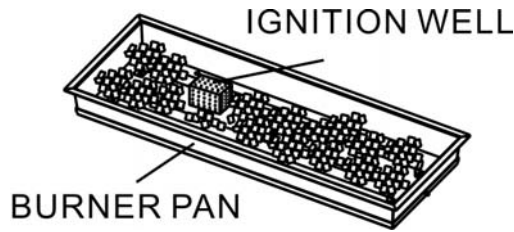

Figure 7

9. Slide the tank drawer out, place the LP tank (not provided) in the drawer and secure it with the chain as shown in Figure 8. With the BLACK lever in the “down/off” position as shown in Figure 9, firmly push the regulator onto the tank valve. To open the valve, lift the BLACK lever and turn the handle 90° clockwise to the “ON” position. See Figure 10. Apply a solution of soapy water to the tank-regulator connection and to the valve-hose connection to check for leaks. If soap bubbles continue to form, the connection has a leak. If a leak is found, close the tank valve and tighten all connections. **NEVER USE A FLAME TO CHECK FOR LEAKS.** In case of gas leakage; for instance, in the event of gas leakage, the appliance shall not be used or if alight, the gas supply shall be shut off and the appliance shall be investigated and rectified before it is used again. To remove the regulator, turn the Black Lever counterclockwise and press straight in. See Figure 11.

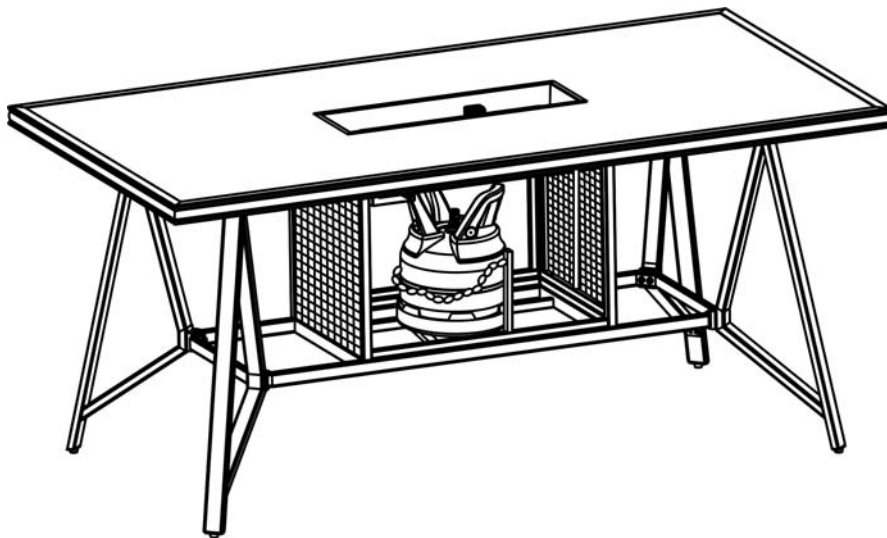

Figure 8



Figure 9

Figure 10

Figure 11



## NATURAL GAS CONVERSION



**Natural gas conversion must be performed only by your natural gas provider or service company.**

1. **SHUT OFF THE GAS SUPPLY TO THE UNIT AND ANY NEARBY ELECTRICAL SOURCE OR APPLIANCES**
2. Below the burner, carefully disconnect flex connector attached to the orifice holder (see step1).
3. Carefully unscrew the orifice holder from the burner pipe (see step2).
4. Remove the propane orifice from the holder and replace with the natural gas orifice (see step2).
5. Install the air shutter over the burner pipe to cover the air holes. Then reattach the orifice holder to the burner pipe (see step3). Special attention should be payed to the leakage between the holder and natural gas orifice. Do the leakage test with the valve opening.
6. Reattach the flex connector to the orifice holder. (see step 4).

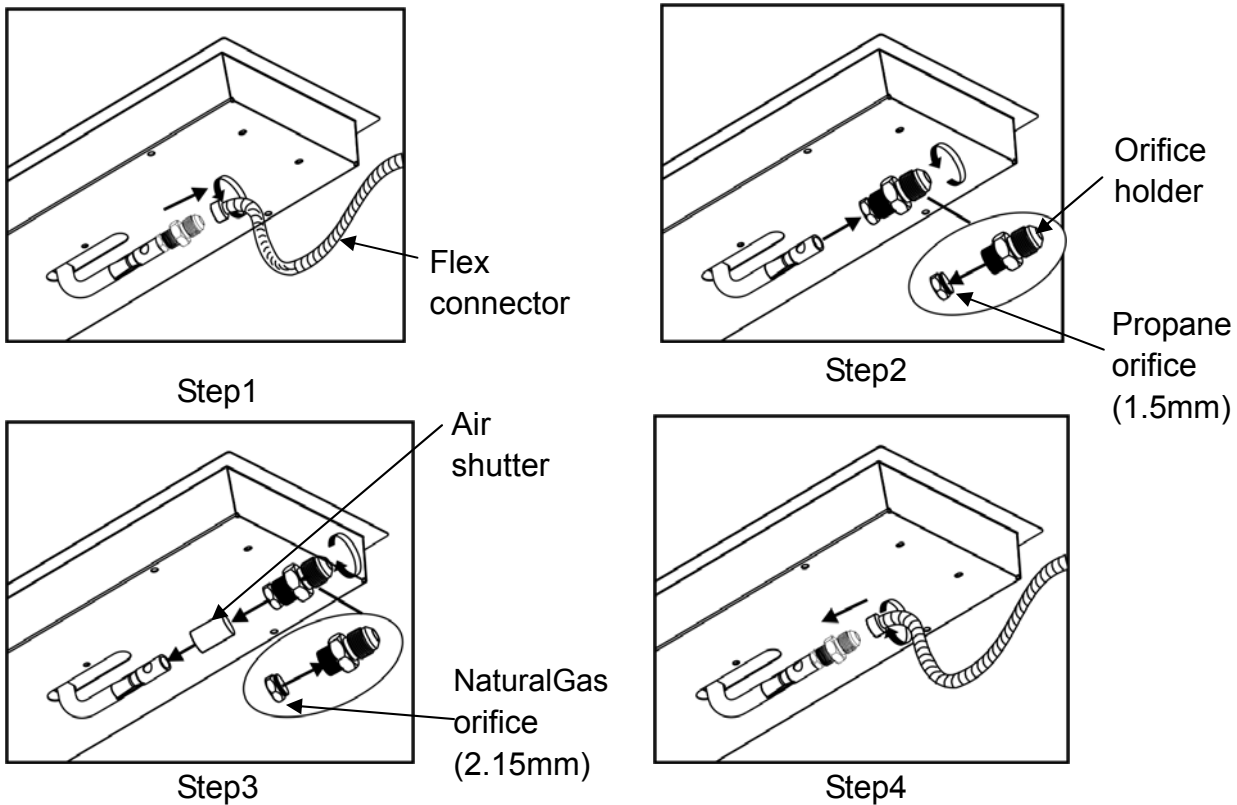

7. To convert the regulator from propane to natural gas, the appliance must be isolated from the gas supply piping system by closing its individual manual shut off valve. Ensure any pressure testing of the gas supply piping system is at test pressure equal to or less than 1/2 psi(3.5KPA)

8. Remove the propane rubber hose from valve and replace with 5/8" natural gas pipe (see step5, natural gas pipe package is not provided).

9. Restore your gas supply and check ALL of the connections for leaks using a solution of soapy water. If a leak is discovered and any bubbles are seen, close the main gas valve and re-tighten

ALL the connections. NEVER USE A FLAME TO CHECK FOR GAS LEAKS!

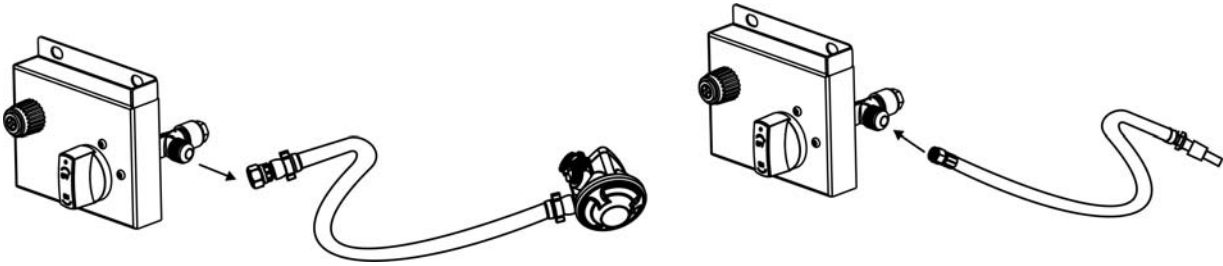

Step5

10. Stick the conversion label on the rating plate as shown in Figure 12.

### Metal Rating Plate

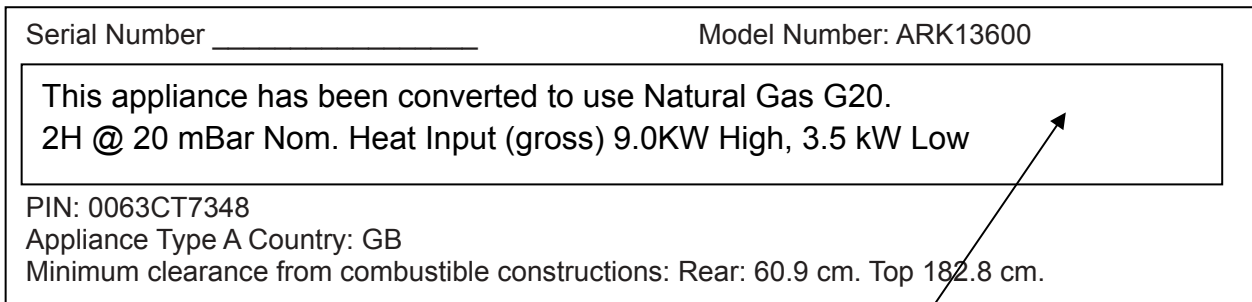
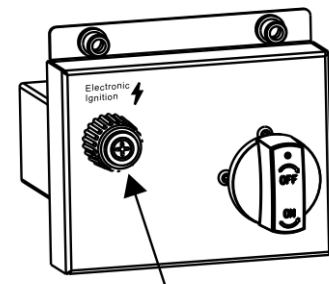

Figure 12

Conversion Label

## BATTERIES

Make sure the control knob is in the "OFF" position. Unscrew the push button cap on the ignition module located on the control panel to access the battery compartment. The ignition module requires one Alkaline AA size battery. The negative (-) end goes in first. See Figure 13. Dispose of the battery safely as it may explode or leak if charged or disposed of in a fire. Make sure of the polarity. Mercury and cadmium free.



IGNITION MODULE

Figure 13

### CAUTIONS: BATTERY INSTRUCTIONS

- Always purchase the correct size and grade of battery most suitable for the intended use.
- Always replace the whole set of batteries at one time, taking care not to mix old and new ones, or batteries of different types.
- Clean the battery contacts and also those of the device prior to battery installation.
- Ensure the batteries are installed correctly with regard to polarity (+ and -).
- Remove batteries from equipment which is not to be used for an extended period of time.
- Remove used batteries promptly.

For recycling and disposal of batteries to protect the environment, please check the internet or your local phone directory for local recycling centers and / or follow local government regulations.



## MAINTENANCE

The flames should look like those in Figure 14. To clean the burner, use a soft brush after the burner has cooled completely. Never use a vacuum cleaner on the burner. It is recommended to store the fire pit indoors during winter if it will be subjected to freezing temperatures. The LP cylinder must be disconnected and removed from the appliance before the appliance can be stored indoors.



Figure 14

## LIGHTING INSTRUCTIONS

Warning: If these instructions are not followed exactly, a fire or explosion may result causing property damage, personal injury, or loss of life.

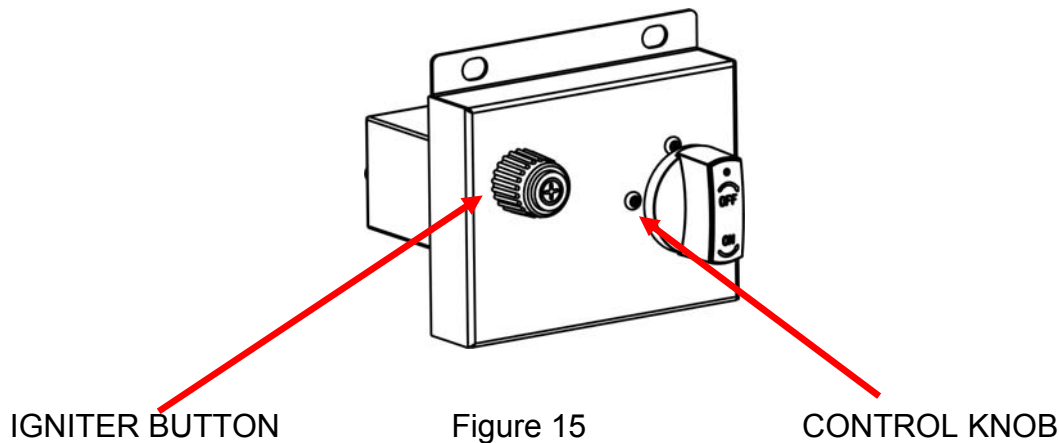

1. Read instructions before lighting.
2. Push and turn the knob to ON.
3. Hold ignitor to light the burner, release control knob after 15 seconds; if burner does not light, wait 5 minutes, repeat.
4. Adjust flame to desired flame with the control knob. See Figure 15.

## BURNER COVER ASSEMBLY

Place the burner cover on the table top as shown in Figure 16.

**WARNING: BEFORE PLACING THE BURNER COVER ON, MAKE SURE THE FIREPIT HAS BEEN SHUT OFF AND THE BURNER HAS COMPLETELY COOLED DOWN.**

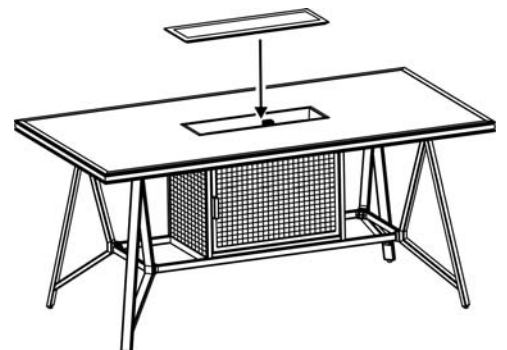
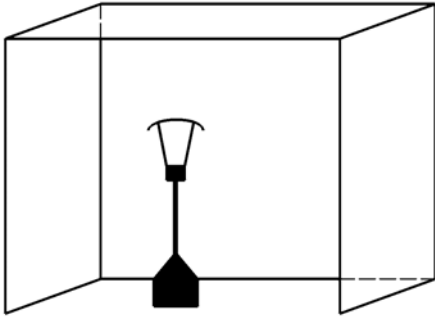

Figure 16

## TROUBLESHOOTING GUIDE

| PROBLEM                              | CAUSE   | REMEDY   |
|--------------------------------------|---|--|
| Burner Won't Light                   | No propane gas at burner                                    | Check that the gas tank valve is open. Turn the control knob to "ON" and push the control knob in. Make sure the tank has propane gas.   |
|                                      | No spark at electrode                                       | Check that the AA battery is installed with the negative (-) end first and has a charge. Check that the wire is connected to the ignition module. Check that the electrode is not cracked or broken. |
|                                      | Lack of oxygen  | Remove excess fire ice from around the ignition well.  |
| Burner won't stay lit after lighting | Thermocouple not in Flame                                   | Check that the tip of the thermocouple is even with the top of the ignition well. Remove any fire ice from the ignition well.  |
|                                      | Thermocouple connection at the main control valve is loose. | Tighten the thermocouple nut at the back of the valve.   |
|                                      | No fire ice on burner                                       | Cover the burner with fire ice per the instructions.   |

- 1) For use outdoors or in amply ventilated areas.
- 2) An amply ventilated area must have a minimum of 25% of the surface area open.
- 3) The surface area is the sum of the walls surface.



The hose should comply with the standard EN16436;  
The regulator should comply with the standard EN16129;  
Close the gas supply at the valve of the gas cylinder or the regulator after use;  
Do not connect the gas cylinder directly to the appliance without the regulator;  
The recommended cylinder size is-max diameter: 310mm, max height: 400mm.

Manufacturer:

Agio International Corporation  
900 E Hamilton Ave, Suite 100, Campbell, CA 95008, USA

Importer :

Costco Wholesale UK Ltd /  
Costco Online UK Ltd  
Hartspring Lane  
Watford, Herts  
WD25 8JS  
United Kingdom  
01923 213113  
[www.costco.co.uk](http://www.costco.co.uk)

MADE IN CHINA  
FABRIQUÉ EN CHINE  
HECHO EN CHINA

## CARE AND MAINTENANCE

### **FRAMES**

*Cleaning* - Use mild soap and warm water. Do not use abrasive materials, cleansers, or bleach products. Rinse with clean water and dry thoroughly.

*Maintenance* - Periodically clean and dry thoroughly. Be sure to drain any water accumulated inside the frames. To thoroughly drain frames, remove foot caps and tilt the frames, if necessary, to remove all water. This is critical. Water allowed to accumulate inside the frames and then exposed to sub-freezing temperatures can cause damage to the frame tubing. Such damage is not covered under warranty. Always clean, drain, and dry thoroughly before storing for the winter. For best results, always store or cover your furniture when not in use.

\*\* When cleaning or moving large or heavy items, always have two people work together. Never drag furniture.

### **FABRICS (CUSHIONS/SLINGS)**

Sunbrella® fabric should be cleaned regularly. Brush off any loose dirt and wash with a mild soap and lukewarm water solution. For stubborn stains and mildew, wash with a solution of 236.6 ml / 1 cup of bleach and 59.2 ml / 0.25 cup of mild soap per 3.79L / 1 gallon of water. Rinse thoroughly to remove soap. Allow fabric to air dry.

*Maintenance* - The best way to maintain the beauty of cushions and slings is to store them in a dry area and out of the elements when not in use, or cover with commercially available outdoor furniture covers.

### SPECIAL WARNINGS

**THIS ITEM IS INTENDED FOR OUTDOOR DOMESTIC USE ONLY, NOT FOR COMMERCIAL USE.**

Furniture covers are a great way to protect your set from harsh elements of weather and UV light. However, it is important to ensure furniture and covers are free of moisture and debris before covering. It is also necessary to promptly uncover furniture after rain and during periods of high humidity to prevent moisture build up. Failure to do so can lead to permanent surface and finish damage.

To ensure longevity of your patio set each seat cushion is made with high density foam. With initial use the seat cushions may feel firm, but with continued use the cushions will continue to soften and provide the ultimate comfort for seasons to come.

## **7 PIECE WOVEN HIGH DINING FIRE SET ITM. / ART. 361115**

# **PATIO FURNITURE ASSEMBLY INSTRUCTIONS IMPORTANT, RETAIN FOR FUTURE REFERENCE: READ CAREFULLY**

### **MISSING PARTS OR DAMAGED PARTS?**

**Please call our customer service**

**US & Canada : 1-888-383-1932 (English and French)  
or contact email address at [customerservice@agio-usa.com](mailto:customerservice@agio-usa.com)**

**CUSTOMER SERVICE HOURS ARE 9:00AM - 5:00PM  
MONDAY - FRIDAY EST.**

International Regions:

Please visit <http://www.agio-usa.com/service-center/costco-international/>  
or contact email address at [customerservice@agio-usa.com](mailto:customerservice@agio-usa.com)

**FOR ADDITIONAL SUPPORT ON CARE AND MAINTENANCE OF  
YOUR AGIO OUTDOOR FURNITURE PLEASE VISIT OUR WEBSITE**

**AT: [www.agio-usa.com/service-center/maintenance/](http://www.agio-usa.com/service-center/maintenance/)**

Agio International Corporation  
900 E. Hamilton Avenue,  
Suite 100, Campbell,  
CA 95008, USA

AFK01330  
ARK13600

**MADE IN CHINA**

## Clay / Porcelain Tabletop

### **About Clay / Porcelain Tile**

Clay / Porcelain Tile is a material that is compressed and heated at high temperatures. Though the material is stain resistant, the grout is porous and could stain. Your tabletop has been sealed and protected with a specially formulated, high quality sealer to minimize staining.

The tabletop can retain heat depending on the outside temperature. In sunny hot weather conditions, care should be exercised when touching the tabletop.

### **Care and Maintenance**

Your tabletop is protected with our specially formulated factory sealer that offers a high level of protection from all stains and acidic liquids and should not break down over time or with normal outdoor use.

The tabletop should not require frequent reapplication of sealer to maintain its durability and the sealer can be easily repaired if it becomes scratched or damaged. However, should you choose to seal your tabletop, you should use only the sealer that was applied to your tabletop during its factory production.

Chemical formulations of sealer products vary and could be incompatible with the sealer that was originally used on your tabletop. Using any sealer other than our factory sealer might produce undesirable results and will void any applicable warranty. Before you reseal your tabletop or to obtain our factory sealer, please visit our website at [www.agio-usa.com/claycare](http://www.agio-usa.com/claycare) or [www.agio-usa.com/porcelaincare](http://www.agio-usa.com/porcelaincare) or call our Customer Service Center in the US and Canada at 1-888-383-1932.

### **Cleaning**

Clay and porcelain are virtually maintenance free. Just keep the table clean with mild soap and water to keep mold & mildew from forming. Simply use clean water and mild dish soap. Clean the tabletop with a soft, clean, white cloth or sponge.

Never use scouring creams, abrasive cleansers, acids, or petroleum based products. Rinse with plenty of clean water to remove soap residue. Dry thoroughly after cleaning to prevent buildup of any residue from minerals that might be present in your water, even with softened water.

### **Spills**

Accidental spills should be cleaned immediately even though your tabletop is sealed. Wipe spills with a clean, soft white cloth. Rinse with clean, warm water and dry thoroughly. The special factory sealer forms a protective barrier that will minimize potential damage to the tabletop by allowing more clean-up time for accidental spills.

### **Recommendations**

To help protect the sealer, use coasters and placemats when dining. Coasters will help absorb sweating by beverage containers and prevent hot containers such as mugs from leaving rings. Placemats will catch spills and prevent dishes from scratching the sealer if dragged across the tabletop. Use trivets or hot pads between dishes and the tabletop to minimize rapid heat transfer. The tabletop can rapidly draw heat from a hot dish and potentially crack the dish. Cover your dining set with an outdoor furniture cover when not in use.

For additional and more detailed information on clay / porcelain tabletop care, sealing the tabletop or to repair damages, visit our website at [www.agio-usa.com/claycare](http://www.agio-usa.com/claycare) or [www.agio-usa.com/porcelaincare](http://www.agio-usa.com/porcelaincare) or call our Customer Service Center in the US and Canada at 1-888-383-1932.



## SOINS ET ENTRETIEN

### **CADRES**

*Nettoyage* : utiliser un savon doux et de l'eau tiède. Ne pas utiliser d'abrasifs, de détergents, ou d'agents de blanchiment. Rincer à l'eau claire et bien sécher.

*Entretien* : périodiquement, nettoyer et sécher soigneusement. Bien drainer toute l'eau accumulée dans les cadres. Pour ce faire, enlever le capuchon de pattes et incliner les cadres, si nécessaire, pour en faire sortir toute l'eau. Ceci est très important. L'eau qui s'accumule dans les cadres, puis est exposée à des températures sous zéro, peut endommager les tubes des cadres. De tels dommages ne sont pas couverts par la garantie. Toujours nettoyer, drainer et sécher soigneusement avant d'entreposer pour l'hiver. Pour de meilleurs résultats, toujours entreposer ou recouvrir le mobilier qui n'est pas utilisé.

Il est recommandé que deux personnes nettoient ou bougent les articles lourds ou encombrants. Ne jamais traîner le mobilier.

### **TISSUS (COUSSINS/LANIÈRES)**

Le tissu Sunbrella® doit être nettoyé régulièrement. Brossez le tissu pour retirer la poussière et lavez-le avec une solution d'eau tiède et de savon doux. Pour les taches tenaces et la moisissure, utilisez une solution composée de 236.6 ml / 1 tasse d'eau de Javel et de 59.2 ml / 0.25 tasse de savon doux pour 3.79L / 1 gal d'eau. Rincez abondamment pour retirer le savon. Laissez sécher à l'air.

*Entretien* : pour préserver l'esthétique des coussins, nous recommandons de ranger le mobilier dans un endroit sec à l'abri des intempéries ou de le couvrir avec une housse pour meubles d'extérieur lorsqu'il n'est pas utilisé.

### **AVERTISSEMENTS SPÉCIAUX!**

**CET ARTICLE EST CONÇU UNIQUEMENT POUR UNE UTILISATION NON COMMERCIALE À L'EXTÉRIEUR.**

Les couvre-meubles sont un excellent moyen de protéger votre ensemble de meubles de patio des éléments climatiques et des rayons UV. Par contre, il est important de s'assurer que les couvertures et les meubles sont exempts de moisissures et de débris avant de les couvrir. Il est aussi nécessaire de rapidement découvrir les meubles après la pluie et durant les périodes de grande humidité afin de prévenir l'accumulation de moisissure. Sinon, cela pourrait mener à des dommages permanents des surfaces et des finis.

Pour assurer la longévité de votre ensemble de patio, chaque coussin de siège est fait de mousse de haute densité. Les coussins de sièges peuvent sembler fermes au début, mais ils s'assoupliront avec le temps et offriront un confort ultime pour des saisons à venir.

**7 PIÈCES ENSEMBLE EN OSIER DE RÉSINE  
TRESSÉ AVEC BRASÉRO  
ITM. / ART. 361115**

## **INSTRUCTIONS D'ASSEMBLAGE POUR MOBILIER DE PATIO**

# **IMPORTANT, À CONSERVER POUR DE FUTURS BESOINS DE RÉFÉRENCE : À LIRE SOIGNEUSEMENT**

**DES PIÈCES MANQUENT OU SONT ENDOMMAGÉES?**

**Veillez communiquer avec notre service à la clientèle**

**Au Canada et aux États-Unis, téléphoner au 1-888-383-1932**

**ou envoyer un courrier électronique à [customerservice@agio-usa.com](mailto:customerservice@agio-usa.com).**

**HEURES D'OUVERTURE DU SERVICE À LA CLIENTÈLE :**  
9 h à 17 h (HNE) DU LUNDI AU VENDREDI.

Régions internationales :

Veillez visiter <http://www.agio-usa.com/service-center/costco-international/>  
ou contacter via l'adresse courriel [customerservice@agio-usa.com](mailto:customerservice@agio-usa.com).

**POUR UN SOUTIEN VIDÉO ADDITIONNEL À L'ASSEMBLAGE, POUR  
RÉSOUTRE DES PROBLÈMES OU POUR L'ENTRETIEN DU MATÉRIEL DE  
PATIO AGIO, SE RENDRE SUR NOTRE SITE WEB :**  
[www.agio-usa.com/service-center/maintenance/](http://www.agio-usa.com/service-center/maintenance/) (en anglais seulement)

Agio International Corporation  
900 E. Hamilton Avenue,  
Suite 100, Campbell,  
CA 95008, USA

AFK01330  
ARK13600

## Vos carreaux de terre cuite / Porcelaine

### **Les carreaux de terre cuite / porcelaine**

La terre cuite / porcelaine est un matériau comprimé et chauffé à haute température. Bien que le matériau soit résistant aux taches, le joint est poreux et pourrait être taché. Votre plateau de table a été scellé et protégé par un joint spécialement conçu et de grande qualité qui devrait minimiser la formation de taches.

Le plateau de table peut retenir la chaleur en fonction de la température à l'extérieur. Lors de journées ensoleillées et chaudes, faire preuve de prudence lorsque l'on touche le plateau de table.

### **Soins et entretien**

Votre plateau de table est protégé grâce à un scellant d'usine spécialement préparé à cet effet. Ce produit offre une protection élevée contre les taches et les liquides acides sans se décomposer avec le temps ou un usage normal à l'extérieur.

Le plateau de table ne nécessite pas d'application régulière de produit d'étanchéité pour maintenir sa durabilité et le joint peut être facilement réparé s'il est rayé ou endommagé. Cependant, si vous choisissez rejointoyer votre table, vous devez utiliser uniquement le même type de joint que celui qui a été appliqué à votre table lors de sa production en usine.

Les formules chimiques peuvent varier d'un joint à l'autre et être incompatibles avec le joint d'origine utilisé pour votre plateau de table. Le fait d'utiliser un joint autre que celui de l'usine pourrait donner des résultats non souhaités et annulera toute garantie applicable. Avant de rejointoyer votre plateau de table ou pour obtenir le joint de l'usine, veuillez visiter le site Web [www.agio-usa.com/claycare](http://www.agio-usa.com/claycare) ou [www.agio-usa.com/porcelaincare](http://www.agio-usa.com/porcelaincare) ou contacter le Centre de service à la clientèle aux États-Unis et au Canada en composant le 1 888-383-1932.

### **Nettoyage**

La terre cuite / porcelaine n'exige à peu près pas d'entretien. Il suffit de nettoyer la table avec du savon doux et de l'eau pour prévenir la formation de moisissures et de champignons. Passer sur la table un chiffon blanc, doux et propre ou bien une éponge. Ne jamais utiliser de crème à récurer, de nettoyeur corrosif, d'acide ou de produit à base de pétrole. Rincer avec beaucoup d'eau propre pour enlever les traces de savon. Sécher complètement après le nettoyage pour prévenir la formation de résidus provenant de minéraux éventuels contenus dans l'eau, même s'il s'agit d'une eau purifiée.

### **Déversements**

Même si le plateau de la table est scellé, les déversements accidentels devraient être nettoyés immédiatement. Essuyer les éclaboussures avec un linge blanc doux et propre. Rincer à l'eau chaude propre et sécher soigneusement. Le joint spécial de l'usine forme une couche protectrice qui minimisera les dommages éventuels causés à la table, en laissant plus de temps pour nettoyer les déversements.

### **Recommandations**

Au moment des repas, utiliser des sous-verres et des napperons afin de protéger le joint. Les sous-verres aideront à absorber la condensation provenant des boissons et à empêcher que des récipients chauds (comme les tasses) laissent des traces sur la table. Les napperons protégeront contre les déversements et empêcheront que les plats rayent le plateau si on les glisse dessus.

Utiliser des dessous de plat ou des chauffe-plats entre la vaisselle et le plateau de table pour minimiser le transfert rapide de chaleur. Le plateau de table peut rapidement aspirer la chaleur d'un plat chaud et potentiellement le fissurer. Couvrir la table d'une housse pour meubles d'extérieur lorsqu'elle n'est pas utilisée.

Pour supplémentaire et plus d'information détaillée sur le soin de table d'argile / porcelaine, le scellant la table ou la réparation de dommages, visiter notre site Web : [www.agio-usa.com/claycare](http://www.agio-usa.com/claycare) ou [www.agio-usa.com/porcelaincare](http://www.agio-usa.com/porcelaincare) ou téléphoner à notre service à la clientèle à les États-Unis et Canada au 1-888-383-1932.

## **CUIDADO Y MANTENIMIENTO**

### **ARMAZONES**

*Limpieza* - Use un jabón suave y agua tibia. No utilice materiales abrasivos, limpiadores o productos con blanqueador. Enjuague con agua limpia y seque por completo.

*Mantenimiento* - Limpie periódicamente y seque bien. Asegúrese de vaciar el agua acumulada dentro del armazón. Para vaciar los armazones, retire las tapas de las patas e incline los armazones, si es necesario, para sacar toda el agua. Esto es importante. Si se permite que se acumule el agua dentro de los armazones y luego se exponen a temperaturas de congelación, puede ocasionar un daño a la tubería del armazón. Tal daño no lo cubre la garantía. Siempre limpie, vacíe y seque bien antes de almacenar durante el invierno. Para mejores resultados, siempre guarde o cubra el mueble cuando no lo use.

\*\* cuando limpie o mueva artículos grandes y pesados, siempre deben hacerlo entre dos personas. Nunca arrastre el mueble.

### **TELAS (COJINES/ASIENTOS)**

La tela Sunbrella® debe limpiarse periódicamente. Quite todo el polvo suelto con un cepillo y lave con una solución de jabón suave y agua tibia. Para manchas más difíciles y moho, lave con una solución de 236.6 ml / 1 taza de blanqueador y 59.2 ml / 0.25 de taza de jabón suave por cada 3.79L / 1 galón de agua. Enjuague bien para eliminar el jabón. Deje que la tela se seque al aire.

*Mantenimiento* - La mejor forma de mantener la belleza de los cojines y de los asientos es guardarlos en un área seca y lejos de la intemperie cuando no se usen o taparlos con fundas para muebles al aire libre disponibles en el mercado.

### **ADVERTENCIAS ESPECIALES**

**ESTE ARTÍCULO ESTÁ DISEÑADO SOLAMENTE PARA USO DOMÉSTICO EN EXTERIORES, NO PARA USO COMERCIAL.**

Las fundas para muebles son una forma estupenda de proteger su conjunto de las inclemencias del tiempo y de la luz UV. Sin embargo, es importante asegurarse de que los muebles y las fundas estén libres de humedad y residuos antes de cubrirlos. Además, es necesario destapar los muebles rápidamente después de la lluvia o durante periodos con mucha humedad para evitar que se acumule. Si no lo hace, puede dañar permanente la superficie y el acabado.

Para asegurar una larga duración de su conjunto de muebles para el patio, todos los cojines de los asientos está fabricados con espuma de alta densidad. Con el uso inicial, los cojines pueden parecer rígidos, pero con el uso continuado se ablandarán y proporcionarán el máximo confort en el futuro.

## **7 PIEZAS JUEGO DE COMEDOR ALTO Y TEJIDO CON FOGÓN**

**ITM. / ART. 361115**

## **INSTRUCCIONES DE ENSAMBLE DE MUEBLES PARA PATIO**

# **IMPORTANTE: CONSERVE PARA FUTURA REFERENCIA. LEA CUIDADOSAMENTE**

**¿PARTES DAÑADAS O FALTANTES?**

**Favor de llamar a nuestro servicio al cliente**

**E.U.A. y Canadá :1-888-383-1932**

**o enviar un correo electrónico a [customerservice@agio-usa.com](mailto:customerservice@agio-usa.com).**

**HORARIO DE SERVICIO AL CLIENTE DE 9:00 a.m. – 5:00 p.m.**

**(HORA DEL ESTE) LUNES - VIERNES**

**(TELÉFONOS Y SERVICIOS NO VÁLIDOS EN ESPAÑA)**

**Regiones internacionales:**

**Por favor vista <http://www.agio-usa.com/service-center/costco-international/>**

**o envíe un correo electrónico a [customerservice@agio-usa.com](mailto:customerservice@agio-usa.com)**

**PARA SOPORTE ADICIONAL EN VIDEO SOBRE EL ENSAMBLE, SOLUCIÓN DE PROBLEMAS, CUIDADO Y MANTENIMIENTO DEL MUEBLE AGIO PARA EXTERIORES, VISITE NUESTRA PÁGINA WEB EN:**

**[www.agio-usa.com/service-center/maintenance/](http://www.agio-usa.com/service-center/maintenance/)**

Agio International Corporation  
900 E. Hamilton Avenue,  
Suite 100, Campbell,  
CA 95008, USA

AFK01330  
ARK13600

**HECHO EN CHINA**

## INFORMACIÓN IMPORTANTE ACERCA DE LOS AZULEJOS DE CERÁMICA (ARCILLA) Y DE PORCELANA

# Superficies de Mesa de Cerámica (arcilla) y Porcelana

### Acerca de los azulejos de cerámica (arcilla) y de porcelana

Los azulejos o losetas de cerámica (arcilla) y de porcelana son materiales que están comprimidos y calentados a altas temperaturas.

Aunque la cerámica (arcilla) y la porcelana son resistentes a las manchas, la lechada es porosa y podría mancharse. La superficie de la mesa ha sido sellada y protegida con un sellador de alta calidad especialmente formulado para minimizar las manchas.

La superficie de la mesa puede conservar el calor dependiendo de la temperatura del exterior. En condiciones de clima cálido y soleado, se debe tener cuidado al tocar la superficie de la mesa.

### Cuidado y mantenimiento

La superficie de la mesa, ya sea de cerámica (arcilla) o de porcelana, está protegida con nuestro sellador de fábrica especialmente formulado que ofrece un alto nivel de protección contra todas las manchas y líquidos ácidos y no debe acabarse con el tiempo o con el uso normal en exteriores.

La superficie de la mesa no debería requerir que se aplique con frecuencia el sellador para mantener su durabilidad y el sellado se puede reparar fácilmente si se raya o daña. Sin embargo, si elige sellar la superficie de la mesa, debe usar sólo el sellador que se le aplicó a la superficie de cerámica (arcilla) o porcelana durante su producción en fábrica.

Las fórmulas químicas de los productos selladores varían y pueden ser incompatibles con el sellador que se utilizó originalmente en la superficie de la mesa. Utilizar un sellador diferente a nuestro sellador de fábrica puede producir resultados indeseables y anulará cualquier garantía aplicable. Antes de volver a sellar la superficie de la mesa o de obtener nuestro sellador de fábrica, por favor, visite nuestra página web en [www.agio-usa.com/claycare](http://www.agio-usa.com/claycare) o [www.agio-usa.com/porcelaincare](http://www.agio-usa.com/porcelaincare) o llame a nuestro Centro de Servicio al Cliente en los E.U.A y Canadá al 1888-383-1932.

(TELÉFONO Y SERVICIOS NO VÁLIDOS EN MÉXICO)

### Limpieza

La cerámica (arcilla) y la porcelana están virtualmente libres de mantenimiento. Sólo mantenga la mesa limpia con jabón suave y agua para evitar la formación de moho. Simplemente use agua limpia y jabón lavaplatos suave. Limpie la superficie de la mesa con un paño blanco suave y limpio o con una esponja. Nunca use cremas para tallar, limpiadores abrasivos, ácidos o productos a base de petróleo. Enjuague con abundante agua para retirar los residuos de jabón. Seque bien después de limpiar para evitar la formación de residuos de minerales que puedan estar presentes en el agua, incluso en el agua blanda.

### Derrames

Los derrames accidentales deben limpiarse de inmediato aunque la superficie de la mesa, tanto de cerámica (arcilla) o porcelana estén selladas. Limpie los derrames con un paño blanco limpio y suave. Enjuague con agua limpia y tibia y seque bien. El sellador especial de fábrica forma una barrera protectora que minimizará el daño potencial de la superficie de la mesa permitiendo así mantenerse limpia durante más tiempo en caso de derrames accidentales.

### Recomendaciones

Para ayudar a proteger el sellador, use portavasos y manteles individuales cuando coma. Los portavasos ayudarán a absorber la humedad de los recipientes con bebidas y a prevenir las marcas que los recipientes calientes tales como tarros pueden dejar. Los manteles individuales captarán derrames e impedirán que los platos rayen el sellador si se arrastran por la superficie de la mesa.

Use salvamanteles o almohadillas para recipientes calientes entre los platos y la superficie de la mesa para minimizar la transferencia rápida de calor. La superficie de la mesa puede extraer rápido el calor de un plato caliente y quebrar potencialmente el plato. Cubra el juego de comedor con una funda para muebles de exteriores cuando no lo use.

Importado por: Importadora Primex S.A. de C.V. Blvd., Magnocentro No. 4,  
San Fernando La Herradura, Huixquilucan, Estado de México, C.P. 52765,  
RFC: IPR-930907-S70, Tel: 52 46 55 00, [www.costco.com.mx](http://www.costco.com.mx)

Para obtener información adicional y más detallada acerca de los cuidados para las superficies de mesa de cerámica (arcilla) y de porcelana, sellando la superficie de mesa, o la reparación de daños, por favor visite nuestro sitio web en [www.agio-usa.com/claycare](http://www.agio-usa.com/claycare) o [www.agio-usa.com/porcelaincare](http://www.agio-usa.com/porcelaincare) o llame a nuestro Centro de Servicio al Cliente en los Estados Unidos y Canadá al teléfono 1-888-383-1932. (TELÉFONO Y SERVICIOS NO VÁLIDOS EN MÉXICO)

\* NOTE: PARTS SHOWN ON PARTS LIST ARE NOT TO SCALE.





\* NOTE : LES PIÈCES ILLUSTRÉES NE SONT PAS À L'ÉCHELLE.

\*NOTA: LAS PIEZAS MOSTRADAS EN LA LISTA DE PIEZAS NO ESTÁN A ESCALA.



The parts shown on parts list are for one single chair.

Les parties qui sont affichées sur la liste des pièces sont pour une seule chaise.

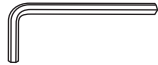
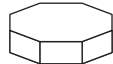
Las piezas que se muestran en la lista de piezas son para una sola silla.

|   | PARTS LIST<br>LISTE DES PIÈCES<br>LISTA DE PIEZAS                                 | QTY<br>QTÉ<br>CANT | ORDER PART #<br>NUMÉRO DE LA PIÈCE<br>#PIEZA DEL PRODUCTO | DESCRIPTION<br>DESCRIPTION<br>DESCRIPCIÓN                          |
|---|---|--------------------|---|--|
| A |  | 1                  | AK1725  | SEAT FRAME<br>CADRE DU FAUTEUIL<br>ARMAZÓN DE LA SILLA             |
| B |  | 1                  | AK1726  | BASE FRAME<br>BASE DU FAUTEUIL<br>PATA IZQUIERDA DE LA SILLA       |
| C |  | 4                  | HW0037  | (25 MM) SCREW<br>(25 MM) VIS<br>(25 MM) TORNILLO                   |
| D |  | 4                  | HW0004  | WASHER<br>RONDELLE<br>ARANDELA                                     |
| E |  | 1                  | HW0252  | ALLEN WRENCH<br>CLÉ HEXAGONALE<br>LLAVE ALLEN                      |
| F |  | 1                  | ZZK03712  | FURNITURE COVER<br>HOUSSE DE PROTECTION<br>CUBIERTA DEL MOBILIARIO |

FACTORY ASSEMBLY (ASSEMBLÉ EN USINE ENSAMBLADA DE FÁBRICA)

|   |   |   |        |  |
|---|---|---|--------|--|
| G |    | 1 | G0383  | FOOTREST COVER<br>COUVERTURE DE REPOSE PIEDS<br>CUBIERTA DE LOS REPOSAPIÉS |
| H |  | 2 | FC0628 | FOOT CAP-1<br>CAPUCHON DE PIED-1<br>TAPA DE LA PATA-1                      |
| I |  | 2 | FC0923 | FOOT CAP-2<br>CAPUCHON DE PIED-2<br>TAPA DE LA PATA-2                      |

MAKE SURE YOU HAVE ALL THE PARTS & HARDWARE AS IDENTIFIED ON THE PARTS LIST  
VÉRIFIER QUE TOUTES LES PIÈCES ET LA QUINCAILLERIE SONT BIEN TELLES QU'IDENTIFIÉES SUR LA  
LISTE DES PIÈCES

LEA ATENTAMENTE ESTE MANUAL ANTES DE USAR O ENSAMBLAR EL PRODUCTO ASEGÚRESE DE  
TENER TODAS LAS PARTES Y ACCESORIOS COMO SE IDENTIFICAN EN LA LISTA DE PIEZAS

# 7 PIECE WOVEN HIGH DINING FIRE SET PIÈCES ENSEMBLE EN OSIER DE RÉSINE TRESSÉ AVEC BRASÉRO PIEZAS JUEGO DE COMEDOR ALTO Y TEJIDO CON FOGÓN

ITM. / ART. 361115

**IMPORTANT, RETAIN FOR FUTURE  
REFERENCE: READ CAREFULLY**

**IMPORTANT, À CONSERVER POUR DE FUTURS  
BESOINS DE RÉFÉRENCE : À LIRE SOIGNEUSEMENT**

**IMPORTANTE: CONSERVE PARA FUTURA  
REFERENCIA. LEA CUIDADOSAMENTE**

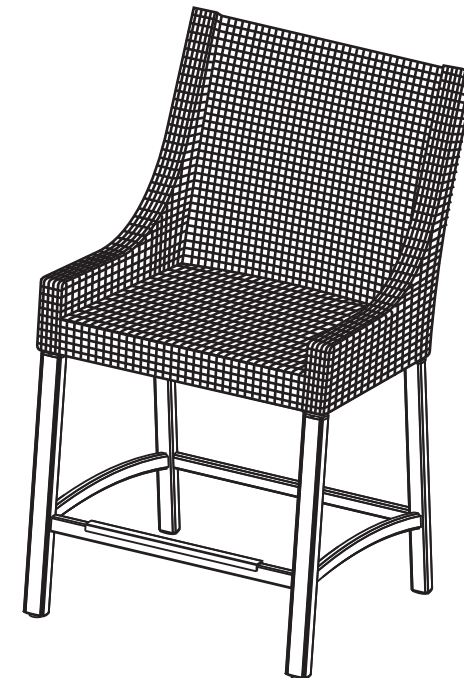

1

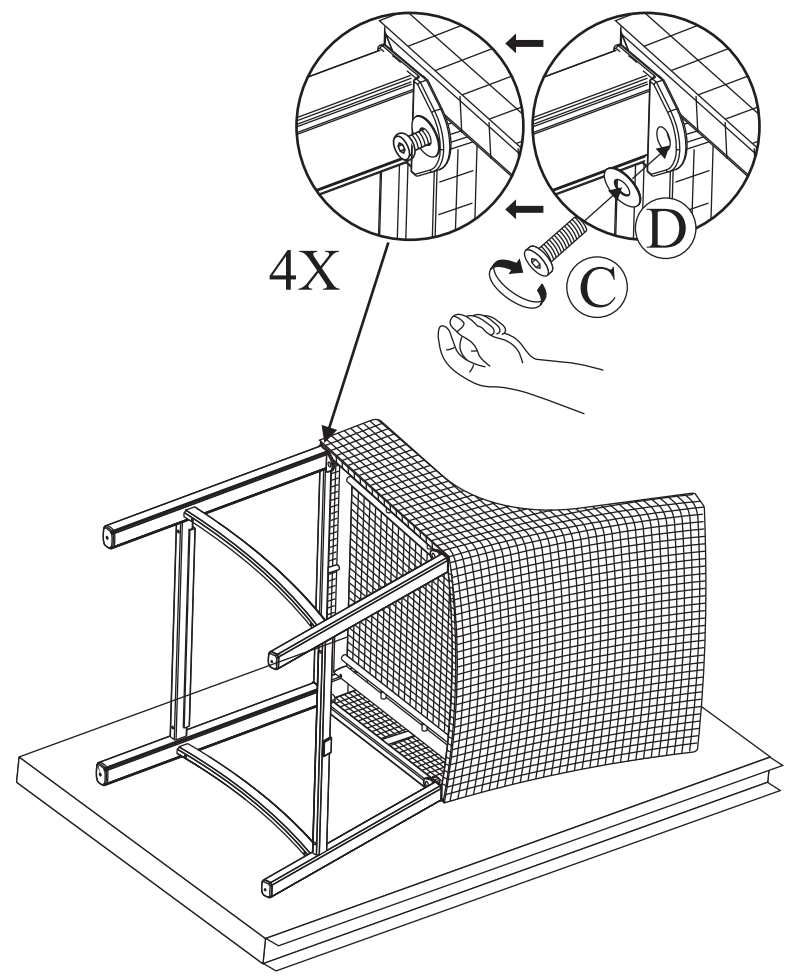
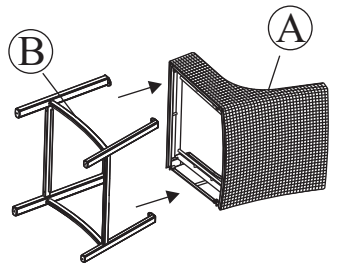

2

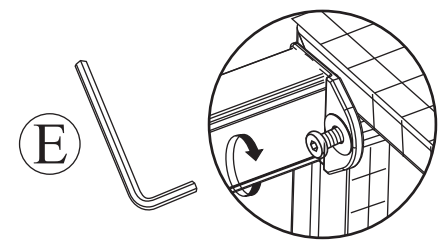

4X

3

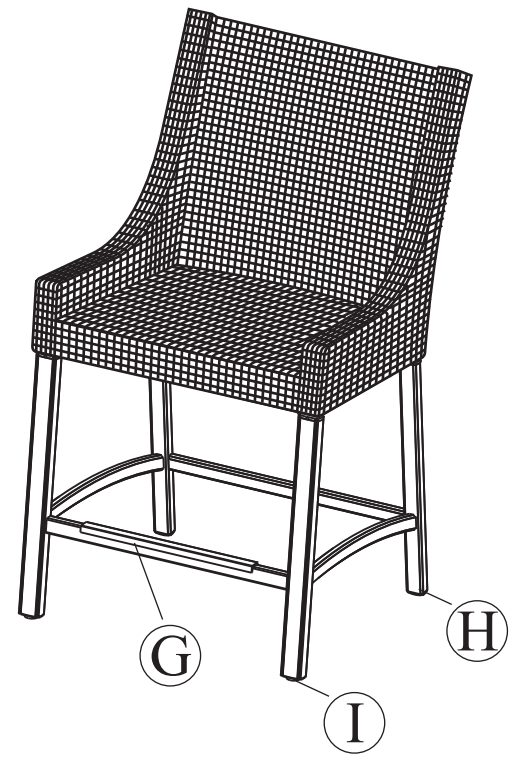
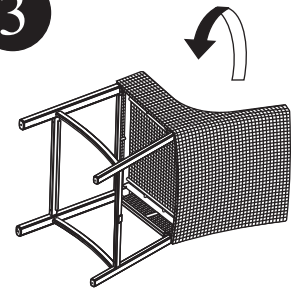

4

F

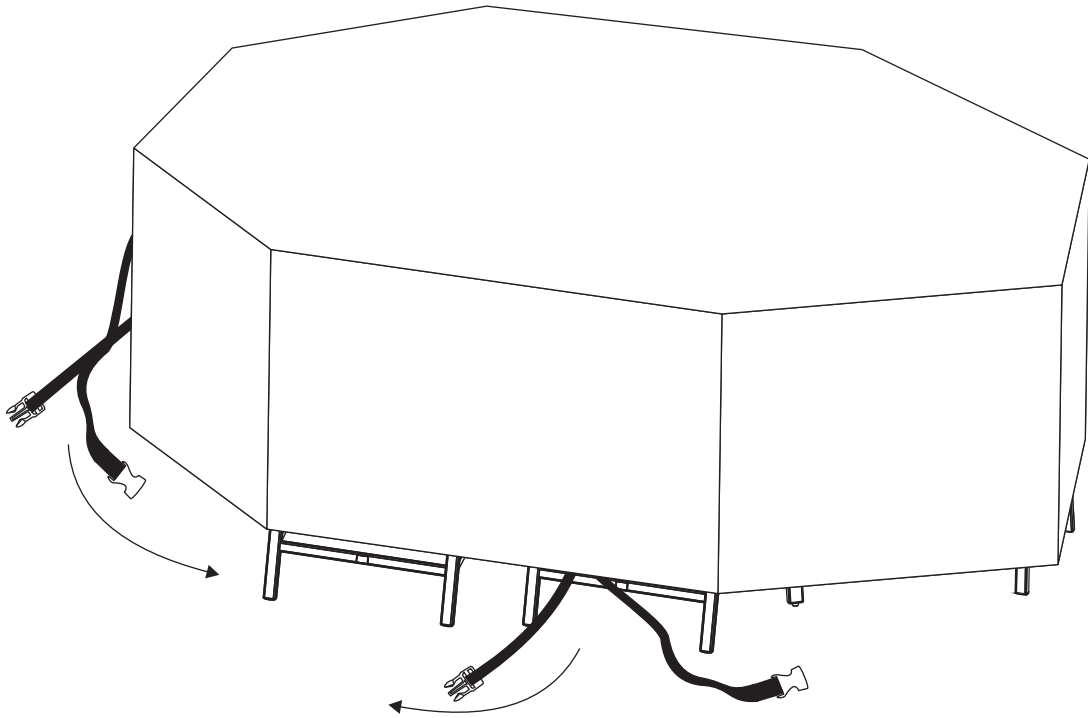
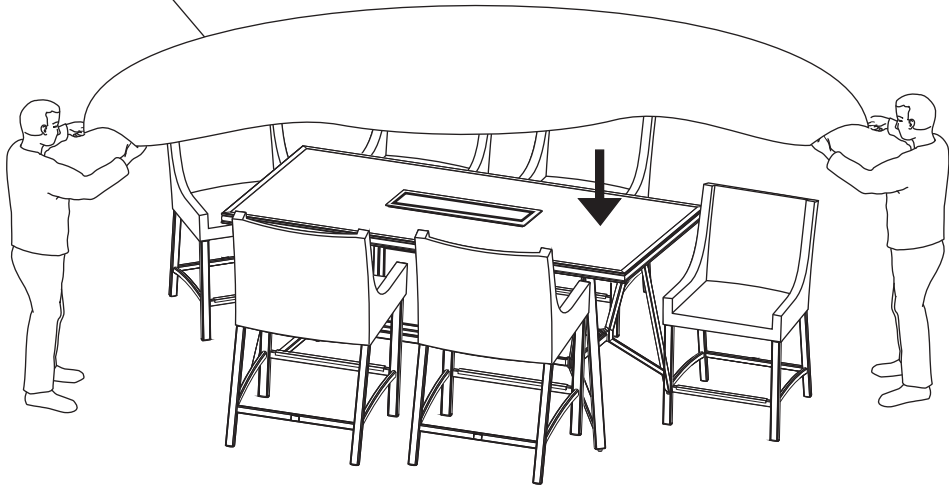

A



B

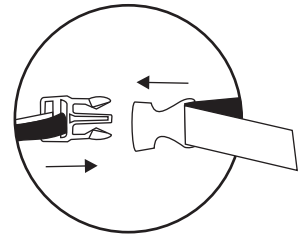

C

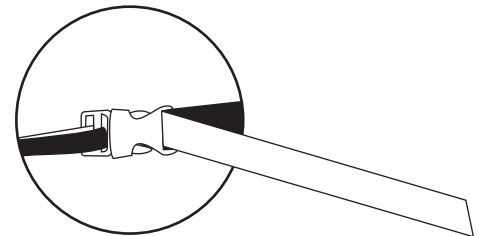
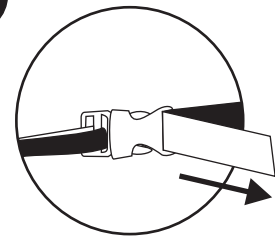

Costco Wholesale UK Ltd /  
Costco Online UK Ltd  
Hartspring Lane  
Watford, Herts  
WD25 8JS  
United Kingdom  
01923 213113  
[www.costco.co.uk](http://www.costco.co.uk)