

Instant Pot®

GOURMET™ CRISP™ + AIR FRYER

MULTI-USE PRESSURE COOKER AND AIR FRYER - 7.6 LITRE



Getting Started Guide

- 2 Important safeguards
- 9 Welcome
- 9 Products, parts and accessories
- 11 Get started
- 13 Pressure cooking - the basics
- 14 Releasing pressure
- 15 Control panel
- 16 Pressure control features
- 20 Cooking
- 28 Care, cleaning and storage
- 32 Troubleshooting
- 34 Warranty

Visit instantbrands.co.uk for the full manual, how-to videos, FAQs, recipe e-books, and more.

Discover your next cooking adventure with the free **Instant Pot app**



Join the **Instant Pot UK community** on Facebook for tips, tricks, and recipe inspiration

IMPORTANT SAFEGUARDS

At Instant Brands™, your safety always comes first. The Instant Pot® was designed with your safety in mind, and we mean business. Check out this Instant Pot's long list of safety mechanisms at instantbrands.co.uk to see what we mean.

When using electrical appliances, basic safety precautions should always be followed:

- 01** READ THIS ENTIRE DOCUMENT BEFORE OPERATING THE APPLIANCE. FAILURE TO FOLLOW THESE SAFEGUARDS AND INSTRUCTIONS MAY RESULT IN INJURY AND/OR PROPERTY DAMAGE.
- 02** Use only the Instant Pot Gourmet Crisp™ pressure cooking lid and Gourmet Crisp air fryer lid with the Instant Pot Gourmet Crisp cooker base. Using any other pressure cooking lids or air fryer lids may cause injury and/or damage.
- 03** To reduce the risk of pressure leakage, cook only in an authorised stainless-steel Instant Pot inner pot. DO NOT use the appliance without the removable inner pot installed.
- 04** Always use an Instant Pot stainless-steel inner pot when using the air fryer lid. DO NOT use a ceramic coated inner pot.
- 05** **⚠ CAUTION** When pressure cooking, do not open the appliance until it has depressurised, and all internal pressure has been released. If the float valve is still up and/or the lid is difficult to open, this indicates that the appliance is still pressurised—do not force it open. Any pressure in the appliance can be hazardous. Refer to **Releasing pressure: Venting methods** for information on releasing pressure. Opening the appliance while it is still pressurised may lead to sudden release of hot contents and may cause burns or other injuries.
- 06** Always operate the appliance on a stable, non-combustible, level surface.
- 07** Do not use the appliance for anything other than its intended use. Failure to follow this instruction may result in injury or property damage.
- 08** For household use only. Do not use outdoors. Not for commercial use.
- 09** **⚠ CAUTION** Do not place the appliance on or in close proximity to a hot gas or electric burner, or a heated oven. Heat from an external

⚠ WARNING

Read this manual carefully and completely and retain for future reference. Failure to adhere to safety instructions may result in serious injury or damage.

IMPORTANT SAFEGUARDS

source will damage the appliance. Failure to follow these instructions may result in injury or property damage.

- 10 **⚠ CAUTION** Do not use the appliance near water or flame. Keep out of direct sunlight. Failure to follow these instructions may result in injury or property damage.
- 11 **⚠ CAUTION** Do not touch hot surfaces. Only use side handles for carrying or moving. Extreme caution must be used when moving the appliance containing hot liquids. Do not move the appliance when it is under pressure.
- 12 **⚠ CAUTION** The cooker base and air fryer lid contain electrical components. To avoid electrical shock, do not put liquid of any kind into cooker base or air fryer lid, and do not immerse power cord, plug, or the appliance in water or other liquid. Do not rinse the appliance under tap.
- 13 **⚠ CAUTION** Do not fill over **PC MAX — 2/3** as indicated on the inner pot. When cooking foods that expand during cooking such as rice or dried vegetables, do not fill the inner pot over — **1/2** line. Overfilling may cause a risk of clogging the steam release pipe and developing excess pressure. Refer to **Cooking: Pressure Cook and Steam**.
- 14 **⚠ WARNING** This appliance cooks under pressure. Make certain the appliance is properly closed before operating. Failure to do so may result in burns, injury and/or property damage. Refer to **Pressure Control Features: Pressure Cooking Lid – Closing the lid**.
- 15 When cooking meat with skin (e.g., sausage with casing), the skin can swell when heated. Do not pierce the skin while it is swollen; this could result in scalding injury.
- 16 **⚠ CAUTION** When pressure cooking food with a doughy or thick texture, or a high fat/oil content, contents may splatter when opening the lid. Please follow recipe instructions for pressure release method. Refer to **Releasing pressure: Venting methods**.
- 17 **⚠ CAUTION** Before using the pressure cooking lid, check the steam release valve, steam release pipe, anti-block shield and float valve for clogging. Failure to do so may result in injury or property damage.
- 18 Do not use this appliance for deep frying or pressure frying with oil.

⚠ WARNING

Read this manual carefully and completely and retain for future reference. Failure to adhere to safety instructions may result in serious injury or damage.

IMPORTANT SAFEGUARDS

- 19 Do not lean over or place your hands or face over the steam release valve or float valve when the appliance is in operation or has residual pressure. Do not touch the metal portion of the lid when the appliance is in operation as this could result in injury.
- 20 Do not cover or obstruct the steam release valve and/or the float valve with cloth or any other objects. Covering or obstructing the steam release valve and/or float valve can create a safety issue and may cause injury.
- 21 Turn the appliance off if steam escapes from the steam release valve and/or float valve in a steady stream for longer than 3 minutes. There may be residual pressure in the appliance. Allow the appliance to depressurise naturally or release all excess pressure before opening. Refer to **Releasing pressure: Venting methods** for information on safe depressurisation.
- 22 Turn the appliance off if steam escapes from the sides of the lid and ensure sealing ring is properly installed. Refer to **Care, cleaning and storage: Removing and installing parts** for information on checking the sealing ring.
- 23 To disconnect, press **Cancel**, then remove plug from power source.
- 24 Unplug from the outlet when not in use, as well as before adding or removing parts or accessories, and before cleaning. To unplug, grasp the plug and pull from the outlet. Never pull from the power cord.
- 25 Regularly inspect the appliance and power cord. Do not operate the appliance if the power cord or plug is damaged, or after the appliance malfunctions or is dropped or damaged in any manner. For assistance, contact Customer Care at **UKSupport@instantbrands.com** (if located in the UK), **EUSupport@instantbrands.com** (if located in the EU), or **+44 (0) 3331 230051**.
- 26 **⚠ CAUTION** Spilled food can cause serious burns. A short power-supply cord is provided to reduce the hazards resulting from grabbing, entanglement and tripping.
 - Keep the appliance and cord away from children.
 - Never drape the power cord over edges of tables or counters.
 - Never use below-counter power outlets, and never use with an

⚠ WARNING

Read this manual carefully and completely and retain for future reference. Failure to adhere to safety instructions may result in serious injury or damage.

IMPORTANT SAFEGUARDS

extension cord.

- 27 **⚠ CAUTION** Do not let the power cord hang over edges of tables or counters, or touch hot surfaces or open flame, including the stovetop.
- 28 Intended for countertop use only. Keep the appliance on a stable, heat-resistant platform. Do not place on anything that may block the vents on the bottom of the cooker base or on the air fryer lid. Leave at least 13 cm of space around the air fryer lid when in use. Do not place the appliance on a hot stove. Do not operate the appliance on or near combustible materials such as tablecloths and curtains.
- 29 **⚠ CAUTION** Do not cover the air vents while the air fryer lid is in operation. Doing so will prevent even cooking and may cause damage to the appliance.
- 30 **⚠ CAUTION** Do not use any accessories or attachments not authorised by Instant Brands Inc. The use of attachments not recommended by the manufacturer may cause a risk of injury, fire or electric shock.
- 31 **⚠ CAUTION** Before inserting the inner pot into the appliance, wipe the outer surface of the inner pot as well as the heating element, located at the bottom of the interior of the cooker base, with a clean dry cloth. Ensure they are dry and free of debris. Refer to **Care, Cleaning and Storage**. Failure to do so may result in injury or property damage.
- 32 Do not attempt to repair, replace or modify components of the appliance, as this may cause electric shock, fire or injury, and will void the warranty.
- 33 Do not tamper with any of the safety mechanisms as this may result in injury or property damage.
- 34 Avoid contact with moving parts as this may result in injury.
- 35 Do not use the appliance in electrical systems other than 220–240V~50/60 Hz. Do not use with power converters or adapters.
- 36 This appliance is NOT to be used by children or by persons with reduced physical, sensory or mental capabilities. Close supervision is necessary when any appliance is used near children and these individuals. Children should not play with this appliance.
- 37 To prevent personal injury and damage to the appliance, only replace the sealing ring with an authorised Instant Pot sealing ring. Visit our

⚠ WARNING

Read this manual carefully and completely and retain for future reference. Failure to adhere to safety instructions may result in serious injury or damage.

IMPORTANT SAFEGUARDS

online store for purchasing details.

- 38** The use of accessory attachments not recommended by the appliance manufacturer may cause injuries.
- 39** Proper maintenance is recommended before and after each use:
- Check the steam release valve, steam release pipe, anti-block shield and float valve on the pressure cooking lid for clogging;
 - Check the heating element and element cover on the air fryer lid for grease and food debris;
 - Prior to inserting the inner pot into the multicooker base, make sure both parts are dry and free of food debris;
 - Let the appliance cool to room temperature before cleaning or storage.
 - Do not allow children to clean or maintain the unit.
See Care, cleaning and storage for more information.
- 40** When using the air fryer lid, do not overfill the air fryer basket. Overfilling may cause food to contact the heating element, which may result in fire and/or personal injury.
- 41** Never connect this appliance to an external timer switch or separate remote-control system.
- 42** **⚠ CAUTION** DO NOT touch accessories during or immediately after cooking. To avoid personal injury,
- Always use heat-resistant hand protection when removing accessories, and to handle the inner pot.
 - Always place hot accessories on a heat-resistant surface or cooking plate.
 - Only place the air fryer lid on the protective pad provided; do not place on countertop.
 - Use extreme caution when disposing of hot grease. Failure to do so may result in serious injury or property damage.
- 43** While cooking, the internal temperature of the appliance reaches several hundred degrees. To avoid personal injury, never place unprotected hands inside the appliance until it has cooled to room temperature.

⚠ WARNING

Read this manual carefully and completely and retain for future reference. Failure to adhere to safety instructions may result in serious injury or damage.

IMPORTANT SAFEGUARDS

- 44 **⚠ CAUTION** When the air fryer lid is in operation, hot air is released through the air vents. Keep your hands and face at a safe distance from the air vents and take extreme caution when removing hot accessories from the appliance. Failure to do so may result in injury or property damage.
- 45 Should the unit emit black smoke when using the air fryer lid, press Cancel and unplug the appliance immediately. Wait for smoking to stop before removing the lid, then clean thoroughly. For further information refer to Troubleshooting online.
- 46 Do not leave the appliance unattended while in use.
- 47 **⚠ CAUTION** Extreme caution must be used when the inner pot contains hot food, hot oil or other hot liquids. Improper use, including moving the air fryer lid or cooker base, may result in personal injury. Do not move the appliance while it is in use.
- 48 Oversized foods and/or metal utensils must not be inserted into the inner pot or air fryer basket as they may cause risk of fire and/or personal injury.
- 49 Do not store any materials in the cooker base or inner pot when not in use.
- 50 Do not place any combustible materials in the cooker base or inner pot, such as paper, cardboard, plastic, Styrofoam or wood.
- 51 Do not use the included accessories in a microwave, toaster oven, convection or conventional oven, or on a ceramic cooktop, electric coil, gas range, or outdoor grill.
- 52 The removable inner pot can be extremely heavy when full of ingredients. Care should be taken when lifting the inner pot from the cooker base to avoid burn injury.
- 53 Use caution when removing the lid. Heat and steam escape as soon as the lid is removed. Never place your face, hands or exposed skin over the appliance opening where heat and steam escape when removing the lid.

SAVE THESE INSTRUCTIONS.

Find your model name and serial number

Model Name: Find it on the rating label on the back of the cooker base, near the power cord.

Serial Number: You can find the serial number on a white sticker near the rating label.

⚠ WARNING

Read this manual carefully and completely and retain for future reference. Failure to adhere to safety instructions may result in serious injury or damage.

IMPORTANT SAFEGUARDS

⚠ WARNING

To avoid injury, read and understand the instructions in this user manual before attempting to use this appliance.

⚠ WARNING

Electrical shock hazard. Use earthed outlet only.

- DO NOT remove earth.
- DO NOT use an adapter.
- DO NOT use an extension cord.

Failure to follow these instructions may result in electric shock and/or serious injury.

⚠ WARNING





THE FAILURE TO FOLLOW ANY OF THE IMPORTANT SAFEGUARDS AND/OR THE INSTRUCTIONS FOR SAFE USE IS A MISUSE OF YOUR APPLIANCE THAT CAN VOID YOUR WARRANTY AND CREATE THE RISK OF SERIOUS INJURY.

Special cord set instructions

Per safety requirement, a short power supply cord is provided to reduce the hazards resulting from entanglement and tripping.

This appliances comes with two power lead. To reduce the risk of electric shock, plug the power lead into an earthed and easily accessible electric socket.

Product specifications

				
Model: GMCO8000	1500 W	220-240 V~ 50-60 Hz	7.6 Litres	10.06 kg

	With Pressure Cooker Lid: cm: 37.5 L × 34.5 W × 36 H
	With Air Fryer Lid: cm: 37.5 L × 34.5 W × 38.8 H

⚠ WARNING

Read this manual carefully and completely and retain for future reference. Failure to adhere to safety instructions may result in serious injury or damage.

Welcome to the world of Instant Cooking

As the new owner of an Instant Pot® Gourmet™ Crisp™ + Air Fryer, we'd like to welcome you to the Instant Community. At Instant Brands™, we are committed to helping homechefs worldwide to cook healthier, and get delicious meals on the table, quicker and easier than ever before. Our multifunctional cooking appliances will ignite your passion for making mealtimes amazing. We have created a world of cooking resources to help you on your journey to create a variety of culinary masterpieces at home.



Download the **Instant Pot app** to access 1000+ recipe ideas.



Join other Instant home chefs on the **Instant Pot UK community on Facebook** for tips, tricks, and inspiration from the recipes they have created.



Subscribe to our e-newsletter to receive regular recipe e-books and find your next dinner favourite.



And of course, we want to hear from you, so don't forget to tag us online **@instantpotuk** and share your experiences and the dishes you create using **#InstantChefAtHome** **#instantpot**.

Say hello to the healthy and convenient alternative to deep frying. The Instant Pot® Gourmet™ Crisp™ + Air Fryer is the best of all possible worlds. With 11-in-1 functionality it does everything a regular Instant Pot® does, but swap out the pressure cooker lid for the innovative air fryer lid, and you've got a whole new set of cooking techniques available – all fast, easy and at the touch of a button. Clear the clutter from your counter and do it all with just one tool.

If you have any comments or queries, please get in touch with us via the helpdesk on **www.instantbrands.co.uk/support/instant-pot-help-desk/** or by sending an email to **UKSupport@instantbrands.com** (if located in the UK) or **EUSupport@instantbrands.com** (if located in the EU). You may also find the Frequently Asked Questions page on our website useful, which answers common Pressure Cooking questions. Finally, don't forget to register your appliance online, simply head to **www.instantbrands.co.uk**.

Product, parts and accessories

See **Care, cleaning and storage: Removing and installing parts** to find out how everything fits together.

Top of pressure cooking lid

Steam release valve

Float valve

Handle

Quick release button

Lid fins

Lid position marker

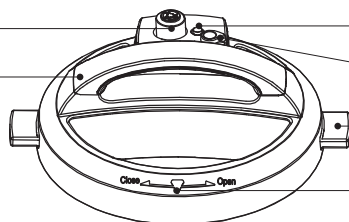

Illustrations in this document are for reference only and may differ from the actual product. Always refer to the actual product.

Product, parts and accessories

Bottom of pressure cooking lid

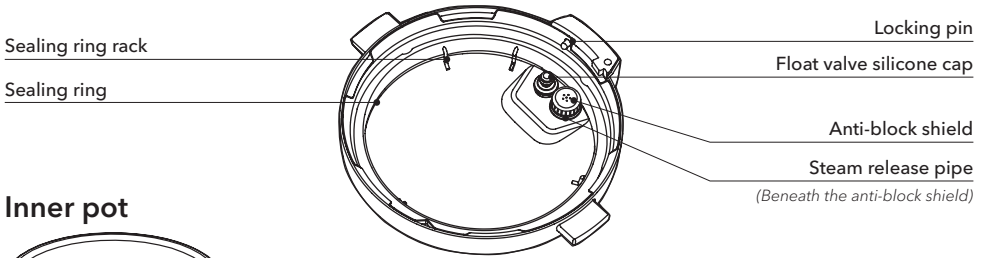

Inner pot

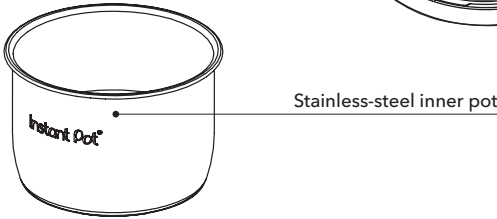

Cooker base

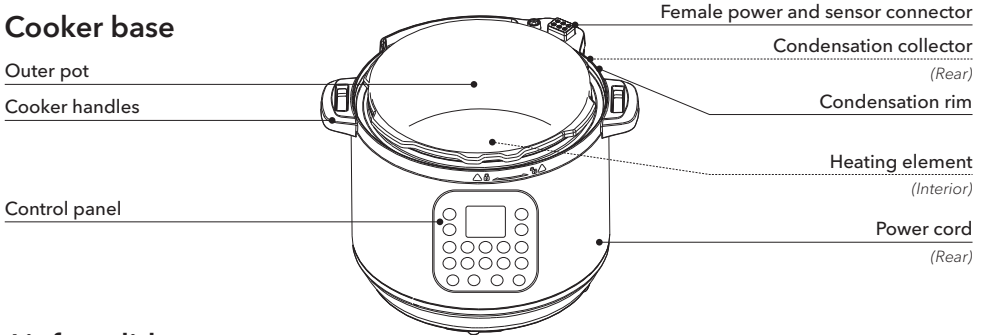

Air fryer lid

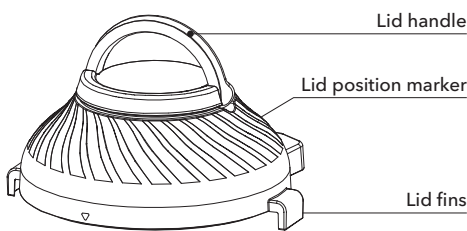

Interior

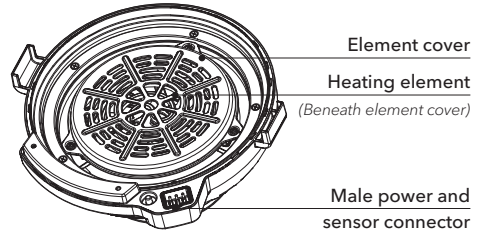

Back

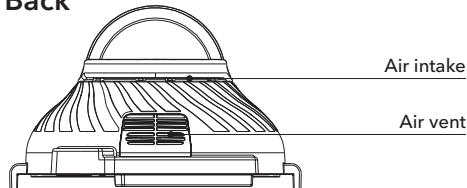

Illustrations in this document are for reference only and may differ from the actual product. Always refer to the actual product.

Product, parts and accessories

Accessories



Grill/dehydrating tray

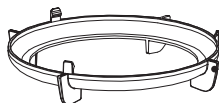

Air fryer basket base

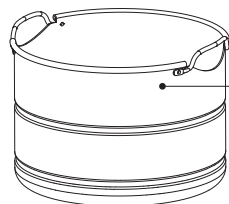

Multi-level air fryer basket

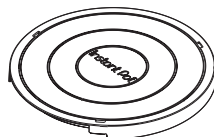

Protective pad and storage cover

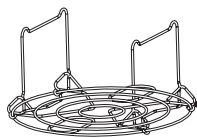

Multi-functional rack

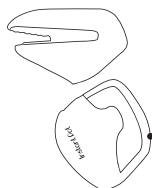

Mini mitts

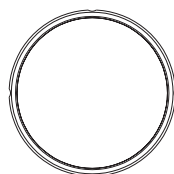

Extra sealing ring

Get started

Initial set up

01 Pull that Gourmet Crisp out of the box!

 Always use a stainless-steel inner pot, not the non-stick ceramic coated variety, with the air fryer lid.

02 Remove the packaging material and accessories from in and around the cooker and make sure all the parts are accounted for. See **Product, parts and accessories** for a full parts breakdown.

 Make sure to check under the inner pot!

03 Wash the inner pot in a dishwasher or with hot water and dish soap. Rinse it well with warm, clear water and use a soft cloth to thoroughly dry the outside of the inner pot.

04 Wipe the heating element with a soft, dry cloth to make sure there are no stray packaging particles left in the cooker base.

WARNING

Read the **Important safeguards** before using the appliance. Failure to read and follow those instructions for safe use may result in damage to the appliance, property damage or personal injury.

Do not place the appliance on a stovetop or upon another appliance. Heat from an external source will damage the appliance.

Do not place anything on top of the appliance, and do not cover or block the steam release valve or anti-block shield, located on the appliance lid.

Get started

 Don't remove the safety warning stickers from the lid or the rating label from the back of the cooker base.

05 You may be tempted to put the Gourmet Crisp on your stovetop – *but don't do it!* Place the cooker base on a stable, level surface, away from combustible material and external heat sources.

Is something missing or damaged?

Get in touch with a Customer Care Advisor by email at UKSupport@instantbrands.com (if located in the UK) or EUSupport@instantbrands.com (if located in the EU) or by phone on +44 (0) 3331 230051 and we'll happily make some magic happen for you!

Initial test run (water test)

Do you *have* to do the water test? No – but getting to know the ins and outs of your Gourmet Crisp prepares you for success in the kitchen! Take a few minutes to get to know how this baby works.

01 Remove the inner pot from the cooker base and add 750 mL of water to the inner pot, then place it back into the cooker base.

02 Connect the power cord to a 220-240 V power source.

The display shows **OFF**.

03 Place and close the pressure cooking lid as described in **Pressure control features: Pressure cooking lid**.

04 Select **Pressure Cook**.

05 Use the **- / + Time** buttons to adjust the cooking time to 5 minutes (**00:05**).

06 Press **Keep Warm** to turn the automatic Keep Warm setting off.

07 Press **Start**. The display shows **On**.

 While the cooker does its thing, read **Pressure cooking - the basics** on the next page to find out how the magic happens.

08 When the Smart Program finishes, the display shows **End**.

09 Follow instructions for a Quick Release in **Releasing pressure: Venting methods**.

⚠ CAUTION Pressurised steam releases through the top of the steam release valve. Keep exposed skin away from the steam release valve.

10 Wait for the float valve to drop, then carefully open and remove the lid as described in **Pressure control features: Pressure cooking lid**.

⚠ DANGER DO NOT attempt to remove the lid while the float valve is up and **NEVER** attempt to force the lid open. Contents are under extreme pressure. Float valve must be down before attempting to remove the lid. Failure to follow these instructions may result in serious personal injury and/or property damage.

11 Using proper hand protection, remove the inner pot from the cooker base, discard the water and thoroughly dry the inner pot.

⚠ CAUTION The inner pot will be hot after cooking. Always use appropriate heat protection when handling a hot inner pot.

That's it! You're good to go :)

Pressure cooking - the basics

When pressure cooking, the Gourmet Crisp goes through 3 stages.

Pre-heating

What you see	What you don't see	Tips
The display shows On .	While the cooker pre-heats, it vaporises liquid to create steam. Once enough steam has built up, the float valve pops up and locks the lid in place.	Frozen foods have the longest pre-heating time. For the fastest results, thaw your food before cooking it.  The time it takes the Instant Pot to pressurize depends on the amount of food and liquid in the inner pot. More food means a longer pre-heating time. No need to hang around during this stage – trust that IP magic!

Cooking

What you see	What you don't see	Tips
The display switches to the cooking countdown timer.	When it reaches the required pressure level, cooking begins. The cooker automatically maintains the cooking pressure at High or Low pressure.	A higher pressure means a higher temperature. Smart Program settings (e.g., cooking time, pressure level, etc.) can be adjusted at any time during cooking.

Depressurisation

What you see	What you don't see	Tips
If Keep Warm is on after cooking, the timer counts up from 00:00 . If not, the cooker returns to standby and displays End .	Although food has finished cooking, the pressure cooker is still pressurised and hot. Reducing the pressure level allows you to safely remove the lid.	Follow your recipe instructions to depressurise the cooker. See Releasing pressure: Venting methods on the next page for safe venting techniques.

DANGER

DO NOT attempt to remove the lid while the float valve is up and NEVER attempt to force the lid open. Contents are under extreme pressure. Float valve must be down before attempting to remove the lid. Failure to follow these instructions may result in serious personal injury and/or property damage.

WARNING

Steam ejected from the steam release valve is hot. DO NOT place hands, face, or any exposed skin over the steam release valve when releasing pressure.	DO NOT cover the steam release valve.
---	--

NOTICE

Do not use QR when cooking fatty, oily, thick or high-starch foods (e.g., stews, chilis, pasta and congee) or when cooking foods that expand when cooked (e.g., beans and grains).



Releasing pressure

You **must** release pressure after pressure cooking before attempting to open the lid. Follow your recipe's instructions to choose a venting method.

Venting methods

Natural Release (NR or NPR)

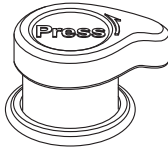
Cooking stops gradually. As the temperature within the cooker drops, the cooker depressurises naturally over time.



What to do	What to expect
<p>Leave the quick release button in the Seal position (popped-up) after cooking completes.</p>  <p>Seal Position</p> <p>Turn Keep Warm off.</p>	<p>Your meal continues to cook even after the Smart Program ends.</p> <hr/> <p> Instant Tip: This is called "carryover cooking" or "resting", and it's great for large cuts of meat.</p> <p>The depressurisation time may vary based upon the volume, type and temperature of food and liquid. It can take up to 40 minutes with some dishes, so plan ahead – it's well worth the wait!</p> <p>When pressure has been fully released, the float valve drops into the lid.</p>

NOTICE

Use NR to depressurise the cooker after cooking high-starch foods (e.g., soups, stews, chilis, pasta, oatmeal and congee) or after cooking foods that expand when cooked (e.g., beans and grains).

Quick Release (QR or QPR)

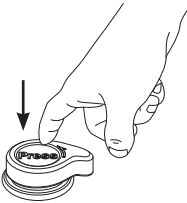
Stops cooking quickly and prevents overcooking. Perfect for quick-cooking vegetables and delicate seafood!

What to do	What to expect
<p>Press the quick release button down until it clicks and locks into the Vent position.</p>  <p>Vent Position</p>	<p>When pressed down, a jet of steam ejects through the top of the steam release valve.</p> <p>This is normal!</p> <p>When pressure has been fully released, the float valve drops into the lid.</p>  <p>Venting</p>

Control Panel



Smart Programs	Pressure cooking lid <ul style="list-style-type: none"> • Pressure Cook • Sauté • Slow Cook • Sterilise • Sous Vide 	Air fryer lid <ul style="list-style-type: none"> • Air Fry • Roast • Bake • Grill • Dehydrate
Time display	The time display shows the time in HH:MM format. Counts up or down, depending on the Smart Program.	
Temperature/ pressure display	Pressure cooking lid: Displays Lo (Low) or Hi (High) pressure level.  When using the Sous Vide Smart Program, the display indicates temperature in °C (Celsius) or °F (Fahrenheit). Air fryer lid: Displays temperature in °C or °F.	
- / + Temp	Adjust the cooking temperature in °C or °F.	
- / + Time	Adjust time for cooking, Delay Start and Keep Warm.	
Keep Warm	Turns the Keep Warm setting on or off.	
Delay Start	Delay the start of cooking.	
Start	Begins the selected Smart Program.	
Cancel	Stop a Smart Program at any time.	

View the full user manual online at instantbrands.co.uk for more information.

Pressure control features (Your little bag of tricks!)

See **Care, cleaning and storage** for installation and removal of parts.

Pressure cooking lid

What we love about it	What you should know about it
<p>When you close it, it sets to Seal automatically, for seriously easy pressure cooking.</p> <p>While plugged in, the Gourmet Crisp plays a little jingle when you open and close the lid.</p>	<p>The lid is removable during non-pressure cooking so you can taste-test as you go.</p> <p>When you're pressure cooking, the lid only locks into place once the cooker has pressurised. Try not to remove the lid unnecessarily while the steam builds inside!</p>

Removing the lid

- 01** Grip the lid handle and turn it anti-clockwise to align the symbol ▼ on the lid with the symbol ⚙▲ on the rim of the cooker base.
- 02** Lift the lid up and off the cooker base towards your body.

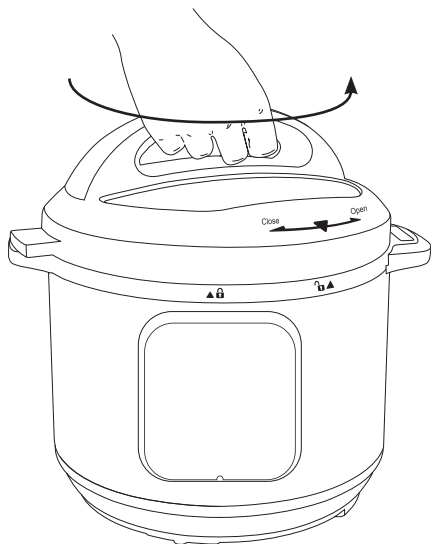

Closing the lid

- 01** Align the symbol ▼ on the lid with the symbol ⚙▲ on the cooker base, then lower the lid onto the track.
- 02** Turn the lid clockwise until the symbol ▼ on the lid aligns with the symbol ⚙▲ on the cooker base

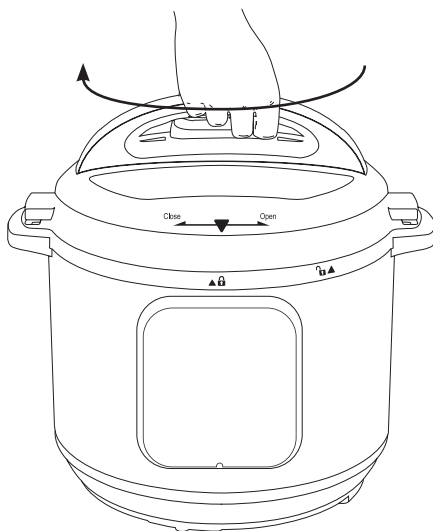

Pressure control features

Quick release button

The quick release button controls the steam release valve – the part controls whether pressure is released or not.

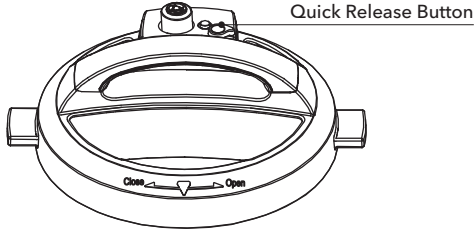

Seal position
Flick to seal.



Vent position
Press to vent.

What we love about it	What you should know about it
It's really easy to use, and keeps our hands far away from the steam!	The lid says Turn to Seal , but it's more like a flicking motion. Don't turn the quick release button more than ¼" (or 45°), and let it spring back to its original position.

See **Releasing pressure: Venting methods** for safe depressurisation techniques.

Steam release valve

The steam release valve sits loosely on the steam release pipe. When the cooker releases pressure, steam ejects from the top of the steam release valve.

The steam release valve is integral to product safety and necessary for pressure cooking.

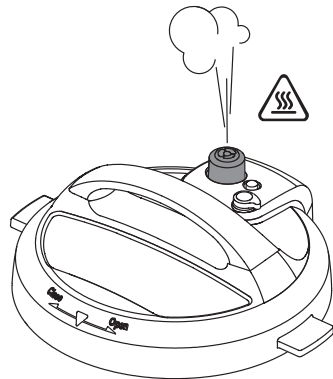

⚠ WARNING

Do not cover or block the steam release valve in any way.

Pressure control features

Sealing ring

When the pressure cooking lid is closed, the sealing ring creates an air-tight seal between the lid and the inner pot.

The sealing ring must be installed before using the cooker. Only one sealing ring should be installed in the lid at a time.

 **Instant Tip:** Silicone is porous, so it absorbs strong aromas and certain flavours. Keep extra sealing rings on hand to limit the transfer of aromas and flavours between dishes.

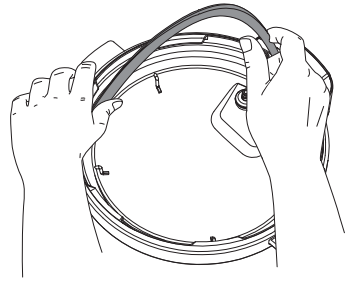

CAUTION

Only use authorised Instant Pot sealing rings. DO NOT use a stretched or damaged sealing ring.

- Always check for cuts, deformation and correct installation of the sealing ring before cooking.
- Sealing rings stretch over time with normal use. The sealing ring should be replaced every 12–18 months or sooner if you notice stretching, deformation, or damage.

Failure to follow these instructions may cause food to discharge, which may lead to personal injury or property damage.

Pressure control features

Float Valve

The float valve is a visual indication of whether there is pressure in the cooker (pressurised) or not (depressurised). It appears in 2 positions:

Pressurised

The float valve has visibly popped up above the surface of the lid.

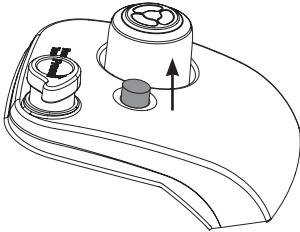

Depressurised

The float valve has descended, and the top is flush with the lid.

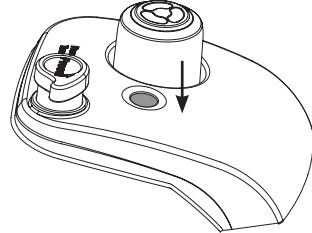

The float valve and silicone cap work together to seal in pressurised steam. These parts must be installed before use. Do not attempt to operate the Instant Pot without the float valve properly installed. Do not touch the float valve during use.

⚠ DANGER

DO NOT attempt to remove the lid while the float valve is up and NEVER attempt to force the lid open. Contents are under extreme pressure. Float valve must be down before attempting to remove the lid. Failure to follow these instructions may result in serious personal injury and/or property damage.

Anti-block shield

The anti-block shield prevents food particles from coming up through the steam release pipe, assisting with pressure regulation.

The anti-block shield is integral to product safety and necessary for pressure cooking.

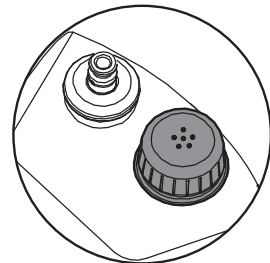

Cooking

The Gourmet Crisp is super versatile in the kitchen – whether you want to pressure cook first and use the air fryer lid to crisp up your dish, or if you'd prefer to cook your meal just using the air fryer lid – you can!

Pressure cooking lid

- Pressure Cook
- Sauté
- Slow Cook
- Sterilise
- Sous Vide

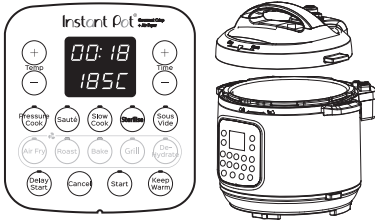

Air fryer lid

- Air Fry
- Roast
- Bake
- Grill
- Dehydrate

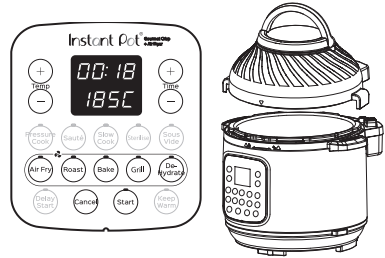

 **Instant Tip:** A jingle sounds when the lids are in the correct position, and the display indicates **OFF**.

WARNING

Do not fill inner pot higher than the **PC MAX — 2/3** line as indicated on the inner pot.

When cooking foods that expand (e.g., rice, beans, pasta) do not fill the inner pot higher than the **— 1/2** line as indicated on the inner pot

Always cook with the inner pot in place. Do not pour food or liquid into the cooker base. To avoid risk of personal injury and/or property damage, place food and liquid ingredients in the inner pot, then insert the inner pot into the cooker base.

Cooking

⚠ CAUTION

Always inspect the lid and inner pot carefully to make sure they are clean and in good working condition before use.

- To avoid personal injury or damage to the appliance, replace the inner pot if it is dented, deformed or damaged.
- Use only authorised Instant Pot inner pots made for this model when cooking. Always make sure the heating element is clean and dry before inserting the inner pot into the cooker base.

Failure to follow these instructions may damage the cooker. Replace damaged parts to make sure safe function.

Pressure Cook and Sterilise

The Pressure Cook Smart Program is a cooking program that uses pressurised steam to ensure your dish is cooked evenly and deeply, for predictably delicious results every time.

The Sterilise Smart Program is cleaning program that uses pressurized steam as well. You can sterilise utensils, tempered glass, and some heat-resistant plastics.

The Gourmet Crisp features 2 pressure levels to choose from:

Pressure level	Suggested use	Notes
Lo (Low) 5.0 - 8.0 psi (35-55 kPa)	Fish and seafood, soft vegetables and rice.	The pressure level controls the temperature, so a higher pressure results in a higher cooking temperature.
Hi (High) 9.4 - 12.3 psi (65-85 kPa)	Sterilise, eggs, meat, poultry, root vegetables, oats, beans, grains, bone broth, stew, chili.	

Pressure level	Minimum liquid required*
7.6 Litres	500 mL

*Unless otherwise specified by your recipe

Liquids for pressure cooking should be water-based, such as broth, stock, soup or juice. If using canned, condensed or cream-based soup, add water as directed below.

⚠ CAUTION

To avoid scorching or scalding injury, be cautious when pressure cooking with more than 60 mL oil, oil-based sauces, condensed cream-based soups, and thick sauces. Add suitable liquid to thin sauces. Avoid recipes that call for more than 1/4 cup 60 mL of oil or fat content.

Cooking

To get pressure cooking, follow the same basic steps as you did in the Initial test run (water test) – but add food this time!

 **Instant Tip:** Using the multi-functional rack will ensure your food items are steamed and not boiled. It helps heat food evenly, prevents nutrients from leeching into the cooking liquid, and stops food items from scorching on the bottom of the inner pot.

When the Smart Program finishes, follow your recipe's directions to select the appropriate venting method. See **Releasing pressure: Venting methods** for safe venting techniques.

Find full instructions for use and pressure cooking timetables online at instantbrands.co.uk.

DANGER

DO NOT attempt to remove the lid while the float valve is up and NEVER attempt to force the lid open. Contents are under extreme pressure. Float valve must be down before attempting to remove the lid. Failure to follow these instructions may result in serious personal injury and/or property damage.

Slow Cook

The Slow Cook Smart Program is comparable to the cooking process of traditional slow cookers, and is compatible for use with any of your slow cooker recipes. Follow recipe directions for slow cooking.

The float valve should not rise during Slow Cook. The lid is removable throughout the cooking process for easy access. If the float valve rises, make sure the quick release button is set to the **Vent** position. Refer to **Releasing pressure: Venting methods**.

Temperature	Suggested use	Notes
Lo (Low)	Commonly used for low and slow, all-day cooking. Set for a minimum of 10 hours for best results.	You can use a lid for slow cooking, if it has a venting hole.
Hi (High)	Slow cooking, but a little bit faster.	Make sure the quick release button is set to Vent .

Find full instructions for use online at instantbrands.co.uk.

Cooking

Sauté

Sauté can be used in place of a frying pan, griddle or flat-top grill. Sautéing meat and vegetables before pressure cooking is the perfect way to boost flavours.

Temperature	Suggested use	Notes
Lo (Low)	Simmer, reduce and caramelize.	The display switches from On to Hot when the inner pot has reached cooking temperature.
Hi (High)	Pan sear, stir-fry, sauté and brown.	As a safety precaution, 30 minutes is the maximum cooking time.

When pressure cooking after using Sauté, deglaze the inner pot to make sure food items do not scorch.

To deglaze: remove food items from the inner pot and add a thin liquid (e.g., water, broth, wine) to the hot surface. Use a wooden or silicone scraper to loosen anything that may be stuck to the bottom of the inner pot.

Find full instructions for use online at instantbrands.co.uk.

⚠ WARNING

The Sauté Smart Program reaches high temperatures. If unmonitored, food may burn on this setting. Do not use the lid and do not leave your cooker unattended while using Sauté.

Sous Vide

Sous Vide cooking involves cooking food underwater, in an air-tight, food-safe bag, for a long period of time. Food cooks in its own juices and comes out delicious and unbelievably tender.

Default time	Time range	Default temperature	Temperature range	Notes
3 hours (03:00)	00:30 - 99:30	56°C	21 - 93°C	Ensure the food in the bag is completely submerged.

Find full instructions for use and sous vide cooking tips and timetables online at instantbrands.co.uk.

Cooking

Air Fry, Roast, Bake, Grill and Dehydrate

Using the air fryer lid is an amazing way to ramp up your meal's flavour and texture.

NOTICE

If the **Food burn** error appears while using the air fryer lid, deglaze the bottom of the inner pot as necessary, according to **Cooking: Sauté** instructions.

⚠ CAUTION

Always ensure the stainless-steel inner pot is present in the cooker base when using the air fryer lid. **DO NOT** use a non-stick ceramic coated inner pot.

Smart program	Default time	Time range	Default temperature	Temperature range	Notes
Air Fry*	18 mins (00:18)	00:01 - 01:00	204°C	82 - 204°C	Place food in air fryer basket or in stainless-steel inner pot.
Suggested uses	Fresh or frozen fries, chicken wings, nuggets, fish fingers and more.				
Roast*	40 mins (00:40)	00:01 - 01:00	193°C	82 - 204°C	Place food in air fryer basket or in stainless-steel inner pot.
Suggested uses	Beef, lamb, pork, poultry, vegetables, scalloped potatoes and more.				
Bake	30 mins (00:30)	00:01 - 01:00	185°C	82 - 204°C	Pour cake batter into oven-safe dish and cover for baking.
Suggested uses	Light and fluffy cakes, buns, pastries and more.				
Grill	8 mins (00:08)	00:01 - 00:40	204°C	Not adjustable	Place food on Grill/dehydrating tray in air fryer basket.
Suggested uses	Melt cheese on nachos or French onion soup.				
Dehydrate	7 hours (07:00)	00:01 - 72:00	52°C	41 - 74°C	Place food under Grill/dehydrating tray in air fryer basket.
Suggested uses	Make your own meat jerky, fruit leather strips, kale crisps and more.				

**You can place food in the air fryer basket, in any oven-safe dish, or directly in the stainless-steel inner pot, but the air fryer basket allows for the best air flow and an even crisp all over.*

Cooking

Air Fry, Roast, Bake, Grill and Dehydrate

01 Insert food into the multi-level air fryer basket, oven-safe cookware, or directly into the inner pot, according to your recipe.

If using an accessory, insert the accessory into the inner pot.

02 Insert the stainless-steel inner pot into the cooker base.

03 Place the air fryer lid on the cooker base by lining up the lid fins and inserting them into the base handles.

 Press the lid down to ensure the power and sensor connectors are in full contact with each other.

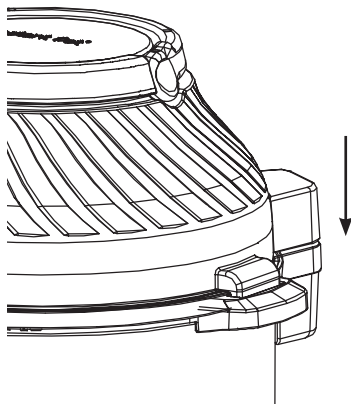

⚠ CAUTION If the power and sensor parts are not fully connected, you may get a **Lid** message or **C9** error. Failure to ensure a proper connection could result in damage to the cooker.

04 Select a Smart Program: **Air Fry, Grill, Bake, Roast** or **Dehydrate**.

05 Use the **+ / -** buttons to adjust the Time and Temperature.

06 Press **Start**.

The display shows **On** as the air fryer lid Preheats. After preheating, the display changes to the set time and counts down.

During Air Fry and Roast, the cooker beeps partway through cooking and the display shows **turn Food**.

07 If you need to remove the lid, carefully lift the air fryer lid off the cooker base and place it on the protective pad provided. Lifting the lid automatically pauses cooking.

08 Carefully turn, flip, or rotate your food, then place the air fryer lid back on the cooker base to resume cooking.

⚠ CAUTION The inner pot and accessories will be hot during and after cooking. To avoid injury, use hand protection and do not touch the inner pot accessories with bare skin.

 Some food doesn't need to be flipped. If you don't remove the lid after the **turn food** indicator appears, cooking continues after 10 seconds.

09 When one minute remains, the display counts down by seconds.

When the Smart Program completes, the cooker beeps and the display shows **End**.

Settings

To do this	Do this
Turn sound on/off.	<p>When in standby, press and hold + above Time until display indicates S On (sound on) or SOFF (sound off).</p> <p> Audible safety and error message alerts cannot be turned off.</p>
Change display temperature °C / °F.	<p>Press and hold + above Temp until the display indicates °C or °F. The temperature is displayed in the unit indicated.</p>
Adjust and save custom cooking times and temperatures.	<p>Once a Smart Program is selected, changes to the cooking time, temperature and pressure level are saved once the Smart Program begins.</p>
Reset an individual smart program.	<p>When in standby, press and hold one Smart Program button until the cooker returns to Standby and displays OFF.</p> <p>The Smart Program's pressure level, cooking time and temperature are restored to the factory default setting.</p>
Reset all smart programs.	<p>When in standby, press and hold Cancel until the cooker beeps.</p> <p>All Smart Program pressure levels, cooking times and temperatures are restored to the factory default setting.</p>

Status messages

OFF	The Gourmet Crisp is in standby mode.
Lid	May indicate that the lid is missing, not properly secured, or that the wrong lid is being used for the Smart Program selected.
On	The cooker is pre-heating.
Hot	The Sauté Smart Program has reached cooking temperature and food may be added to the inner pot.
00:00	Display shows one of the following: <ul style="list-style-type: none">• When Delay Start is running, the cooker counts down until the Smart Program begins;• When a Smart Program is running, the cooker counts down the remaining cooking time;• When Keep Warm is running, the cooker counts the length of time that food has been warming.
End	The Smart Program has ended and Keep Warm is off.
Food burn	The cooker is overheating. See Troubleshooting for more information.
E*	An error has occurred. See Troubleshooting for information on error codes.

Care, cleaning and storage

Clean your Gourmet Crisp and its parts after each use. Failure to follow these cleaning instructions may result in catastrophic failure, which may lead to property damage, severe personal injury and/or death.

Always unplug your cooker and let it cool to room temperature before cleaning. Never use metal scouring pads, abrasive powders or harsh chemical detergents on any of the Instant Pot's parts or accessories.

Let all surfaces dry thoroughly before use, and before storage.

Parts	Cleaning methods and instructions
Accessories <ul style="list-style-type: none"> • Multi-functional rack • Protective pad and storage cover • Grill/dehydrating tray • Multi-level air fryer basket • Basket base 	Dishwasher safe if placed on top rack, otherwise clean with a damp cloth and mild dish soap and rinse well with clear, warm water. <ul style="list-style-type: none"> • Disassemble the air fryer accessories before cleaning. • Optionally, spray the Grill/dehydrating tray and/or basket interior with non-stick cooking spray before adding food. • Use the reverse side of the protective pad to cover the Air Fryer Lid when storing.
Pressure Cooking Lid and parts <ul style="list-style-type: none"> • Condensation collector • Anti-block shield • Sealing ring • Steam release valve • Float valve • Silicone cap 	Remove all the parts from the lid before cleaning. See Care, cleaning and storage: Removing and installing parts. <ul style="list-style-type: none"> • With the steam release valve and anti-block shield removed, clean the interior of the steam release pipe to prevent clogging. • To drain water from the lid after dishwashing, grasp the lid handle and hold the lid vertically over a sink, then turn it 360°— such as turning a steering wheel. • After cleaning, store the lid upside down on the cooker base. • Check the condensation collector after each use and empty as needed. Do not allow food or moisture to stagnate in the condensation collector. • Store sealing rings in a well-ventilated area to decrease residual odour of flavourful meals. To eliminate odours, add 250 mL water and 250 mL white vinegar to inner pot, and run Pressure Cook for 5-10 minutes, then QR pressure.
Air fryer lid	Clean with a barely-damp cloth and mild dish soap, then use a clean, barely-damp sponge to remove the soap residue. DO NOT machine wash. <ul style="list-style-type: none"> • Wipe it dry with a soft cloth. • Always check the element cover for oil spatter and food debris and remove it before turning on the air fryer lid. • To remove baked-on grease and food residue, spray the element cover with a mixture of baking soda and vinegar and wipe clean with damp cloth. • For stubborn stains, allow the mixture to sit on the affected area for several minutes before scrubbing clean. • Note: Make sure not to use anything more abrasive than a toothbrush to scrub the element cover. • DO NOT remove the element cover. • DO NOT rinse or immerse the air fryer lid in water or other liquid.
Cooker base	Clean with a barely-damp cloth and mild dish soap, then use a clean, barely-damp sponge to remove the soap residue. DO NOT machine wash. <ul style="list-style-type: none"> • Make sure to clean the inside of the outer pot as well as the condensation rim. Allow the area to dry completely before inserting the inner pot. • Clean the stainless-steel exterior and control panel with a soft, barely damp cloth or sponge.
Power cord	Wipe clean with a barely-damp cloth as needed.

Some discoloration may occur after machine washing, but this will not affect the cooker's safety or performance.

Care, cleaning and storage

⚠ WARNING

The Instant Pot cooker base contains electrical components. To avoid fire, electric leakage or personal injury, make sure the cooker base stays dry.

- DO NOT immerse the cooker base in water or other liquid, or attempt to cycle it through the dishwasher.
- DO NOT rinse the heating element.
- DO NOT submerge or rinse the power cord or the plug.

Removing and installing parts

Silicone sealing ring

Remove the sealing ring

Grip the edge of the silicone and pull the sealing ring out from behind the circular stainless-steel sealing ring rack.

With the sealing ring removed, inspect the steel rack to make sure it is secured, centred, and at an even height all the way around the lid. Do not attempt to repair a deformed sealing ring rack.

 **The sealing ring** is easiest to remove and install when it is wet and soapy.

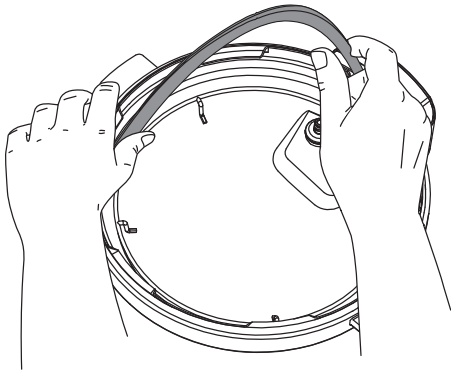

Install the sealing ring

Place the sealing ring over the sealing ring rack and press it into place. Press down firmly to prevent puckering.

When installed properly, the sealing ring is snug behind sealing ring rack and should not fall out when the lid is turned over.

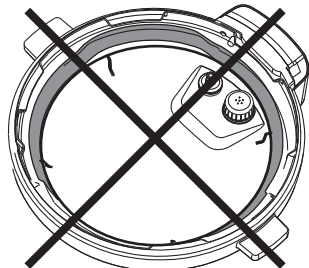
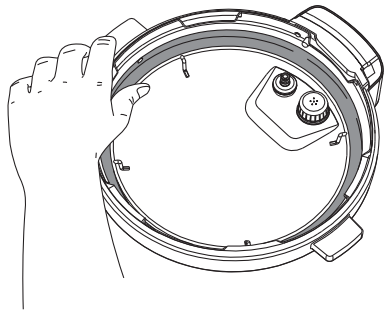

Incorrect

Care, cleaning and storage

Steam release valve

Remove the steam release valve

Pull the steam release valve up and off the steam release pipe.

The steam release valve must be installed before using the cooker.

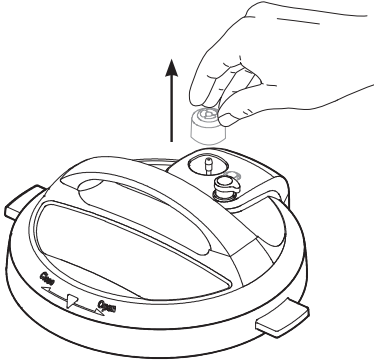

Install the steam release valve

Place the steam release valve on the steam release pipe and press down firmly.

The steam release valve sits loosely on the steam release pipe when installed properly but should remain in place when the lid is turned over.

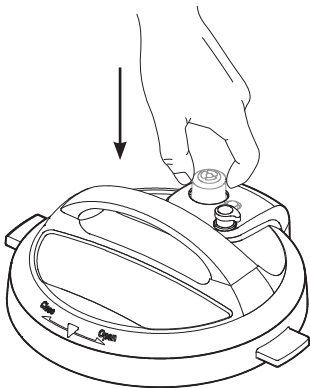

Anti-block shield

Remove the anti-block shield

Grip the lid like a steering wheel and use your thumbs to press firmly against the side of the anti-block shield (pressing towards the side of the lid and up) until it pops off the prongs underneath.

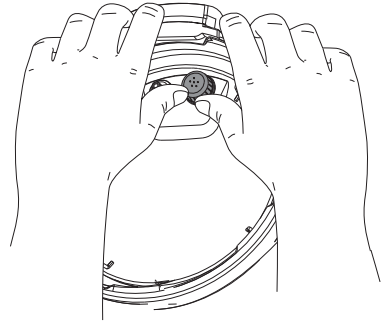

Install the anti-block shield

Place the anti-block shield over the prongs and press down until it snaps into position.

Do not attempt to operate the pressure cooker without the anti-block shield installed.

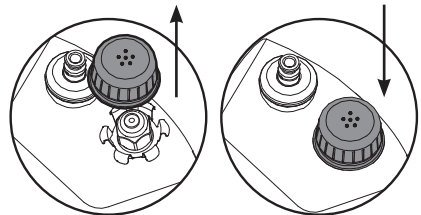

Care, cleaning and Storage

Float valve and silicone cap

Remove the float valve from the lid

Place one finger on the flat top of float valve, then turn the lid over. Detach the silicone cap from the bottom side of the float valve.

Remove the float valve from the top of the lid. Do not discard the float valve or silicone cap.

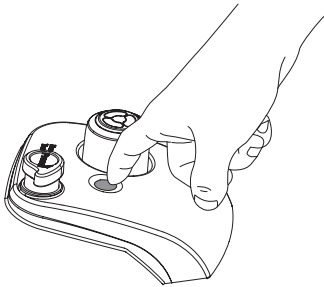

Top

Install the float valve

Drop the narrow end of the float valve into the float valve hole on the top of the lid. Place one finger on the flat top of the float valve, then turn the lid over. Firmly attach the silicone cap to the bottom of the float valve.

Do not attempt to operate the pressure cooker without the float valve and/or silicone cap properly installed in the pressure cooking lid.

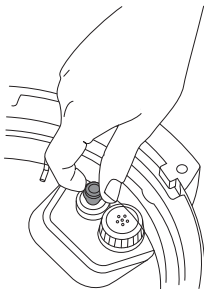

Bottom

Condensation collector

The condensation collector sits at the back of the cooker base and catches any overflow from the condensation rim.

It should be installed before cooking, then emptied and rinsed out after each use.

Remove the condensation collector

Pull the condensation collector away from the cooker base; do not pull down. Note the tabs on the cooker base and the grooves on the condensation collector.

Install the condensation collector

Align the grooves on the condensation collector over the tabs on the back of the cooker base and slide the condensation collector into place.

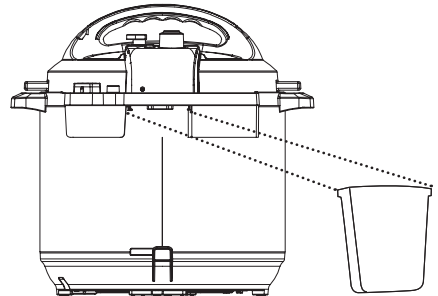

Troubleshooting

Register your Gourmet Crisp today at instantbrands.co.uk/support/register-your-product/.

Get in touch with a Customer Care Advisor by email at UKSupport@instantbrands.com (if located in the UK), EUSupport@instantbrands.com (if located in the EU), or by phone on **+44 (0) 3331 230051**.

View the full Troubleshooting table online at instantbrands.co.uk.

Problem	Possible reason	Try this
The display remains blank after connecting the power cord.	Bad power connection or no power.	Inspect power cord for damage. If damage is noticed, contact Customer Care . Check outlet to make sure it is powered.
	Cooker's electrical fuse has blown.	Contact Customer Care .
Steam leaks from side of lid.	No sealing ring in the lid.	Install a sealing ring.
	The sealing ring is damaged or not installed properly.	Replace the sealing ring.
	Food debris attached to the sealing ring.	Remove the sealing ring and clean it thoroughly.
	The lid is not closed properly.	Open, then close the lid.
	The sealing ring rack is warped or off-centre.	Remove the sealing ring from the lid, then check the sealing ring rack for bends or warps. Contact Customer Care .
	The inner pot rim may be misshapen.	Check for deformation and contact Customer Care .
Minor steam leaking or hissing from the steam release valve during the cook cycle.	Quick release button is not in the Seal position.	Flick the quick release button to make sure it is in the Seal position.
	Cooker is regulating excess pressure.	This is normal; no action required.
Steam gushes from the steam release valve when the quick release button is in the Seal position.	Not enough liquid in the inner pot.	Add 500 mL of thin water-based liquid to the inner pot according to its size.
	Pressure sensor control failure.	Contact Customer Care .
	Steam release valve is not seated properly.	Flick the quick release button to make sure it is in the Seal position.

Troubleshooting

Problem	Possible reason	Try this	
Black smoke is coming from the air fryer lid.	⚠ CAUTION Cancel the Smart Program, unplug the cooker and allow it to cool to room temperature.		
	Using an oil with a low smoke point.	Choose a neutral oil with a high smoke point, such as Canola, Avocado, Soybean, Safflower, or Rice Bran.	
	Food residue on the bottom of the inner pot or around the element on the air fryer lid.	Remove all accessories from the inner pot and clean the inner pot, air fryer lid, and all accessories thoroughly.	
	Appliance malfunction.	Contact Customer Care .	
Error code appears on the display and the cooker beeps continuously.	C1 C2 C6 C6H C6L	Faulty sensor.	Contact Customer Care .
	C5	Temperature is too high because the inner pot is not in the cooker base.	Press Cancel and wait for heating element to cool; make sure there are no foreign objects in cooker base; insert or reposition inner pot in cooker base and re-enter commands.
		Temperature is too high.	Check for scorching on bottom of inner pot. Add thin, water-based liquid to the inner pot according to its size.
	C7	Heat element has failed.	Contact Customer Care .
		Not enough liquid.	Add thin, water-based liquid to the inner pot according to its size
		Quick release button is in the Vent position.	Flick quick release button to make sure it is in the Seal position.
	Lid	Lid is not in the correct position for the selected program.	Open and close the lid. Do not use a lid when using Sauté.
	Food burn	High temperature detected at bottom of inner pot; cooker automatically reduces the temperature to avoid overheating.	Starch deposits at the bottom of the inner pot may have blocked heat dissipation. Turn the cooker off, release pressure according to the recipe, and inspect the bottom of the inner pot.
PrSE	Pressure has accumulated during a non-pressure cooking program.	Press quick release button down until it clicks into Vent position.	

Any other servicing must be performed by an authorized representative.

Warranty

Limited Warranty

Instant Brands (EMEA) Limited, Instant Brands (Ireland) Limited, and Instant Brands Inc. (collectively the "Company") warrant this appliance to be free from defects in workmanship and material, under normal household use, for a period of two (2) years from the date of original purchase. This Limited Warranty extends only to the original purchaser and use of the appliance in the UK and EU. This warranty does not cover appliance use outside of the UK and EU.

Proof of original purchase date and, if requested, return of your appliance is required to obtain service under this Limited Warranty. Provided that this appliance is operated and maintained in accordance with the written instructions included with the appliance (which are also available at instantbrands.co.uk), the Company will, at its sole discretion, either: (i) repair defects in materials and workmanship; or (ii) replace the appliance. In the event the appliance is replaced, the Limited Warranty on the replacement appliance will expire 24 months from the date of original consumer purchase.

The Company is not responsible for shipping costs for warranty service.

Limitation and Exclusions

Any modification or attempted modification to your appliance may interfere with the safe operation of the appliance and may result in serious injury and damage. Any modification or attempted modification to your appliance or any part thereof will void the warranty, unless such modification(s) or alteration(s) were expressly authorised by the Company.

This warranty does not cover (1) normal wear and tear; (2) damage resulting from negligent, unreasonable or misuse of the appliance, improper assembly or disassembly, use contrary to the operating instructions, failure to provide reasonable and necessary maintenance, Acts of God (such as fire, flood, hurricanes and tornadoes), or repair or alteration by anyone, unless expressly directed and authorised by the Company; and (3) repairs where your appliance is used for other than normal household use and in a manner contrary to published user or operator instructions.

To the extent permitted by applicable law, the liability of the Company, if any, for any allegedly defective appliance or part shall be limited to repair or replacement of the appliance or part thereof, and shall not exceed the purchase price of a comparable replacement appliance. Except as expressly provided herein and to the extent permitted by law, (1) the Company makes no warranties, conditions or representations, express or implied, usage, custom of trade or otherwise with respect to the appliance or parts covered by this warranty and (2) the Company shall not be responsible or liable for indirect, incidental or consequential damages arising out of or in connection with the use or performance of the appliance or damages with respect to any economic loss, loss of property, loss of revenues or profits, loss of enjoyment or use, costs of removal, installation or other consequential damages of any nature or kind.

You may have rights and remedies under applicable laws, which are in addition to any right or remedy which may be available under this limited warranty.

Warranty

Warranty Registration

Please visit instantbrands.co.uk/support/register-your-product/ to register your appliance. You will be asked to provide your name, your email address, the store name, date of purchase, model number and serial number (both of which are found on the appliance). This registration will enable us to keep you up-to-date with product developments and recipes, and contact you in the unlikely event of a product safety notification. By registering, you acknowledge that you have read and understood the instructions for use and warnings accompanying the appliance.

Warranty Service

- Your name, email address or phone number.
- A copy of the original purchase receipt with order number, model and serial number.
- A description of the product defect, including any photographs or video if possible.

Warranty Registration

Within the UK

Instant Brands (EMEA) Limited,
1 Christchurch Way,
Woking, Surrey,
GU21 6JG, UK.

Email: UKSupport@instantbrands.com
Telephone: +44 (0) 3331 230051

Within the EU

Instant Brands (Ireland) Limited,
Suite 6, Rineanna House,
Shannon Free Zone,
Shannon, Co Clare,
Ireland, V14 CA36.

Email: EUSupport@instantbrands.com
Telephone: +44 (0) 3331 230051

This warranty was last updated on 1 September 2019 for all products sold from [1 November 2019]. If your product comes with our older warranty version, your warranty will continue to be honoured.

Recycling

This appliance complies with the WEEE Directive 2012/19/EU on the disposal of electrical and electronic equipment (WEEE). This appliance complies with the European directive for electromagnetic compatibility (EMC) 2014/30/EU and its revisions, as well as Low Voltage Directive (LVD) 2014/35/EU and its revisions.

This marking indicates that this product should not be disposed of with other household waste throughout the UK and EU. To prevent possible harm to the environment or human health from uncontrolled waste disposal, recycle it responsibly to promote the sustainable re-use of material sources. To return your used device, please use the return and collection systems or contact Customer Care for further recycling and WEEE information.



Instant Pot®

Instant Brands (EMEA) Limited,

1 Christchurch Way,
Woking, Surrey,
GU21 6JG, UK.

Instant Brands (Ireland) Limited

Suite 6, Rineanna House,
Shannon Free Zone,
Shannon, Co Clare,
Ireland, V14 CA36.

Register your product today

instantbrands.co.uk/support/register-your-product/

Subscribe to our newsletter

Contact us

+44 (0) 3331 230051

EUSupport@instantbrands.com

UKSupport@instantbrands.com

instantbrands.co.uk

Download Free App



Tag us in your creations

 @instantpotUK

 @InstantpotUK

 @instantpotUK

 @InstantpotUK

 @InstantBrandsUK