

Affix Serial Number  
HERE

Using the unique serial number, simply register your product using the QR code above.

Customer Service: Call: +44 (0) 1889 272 056

# Parts List

Part Ref: 0206-01  
Qty: x2

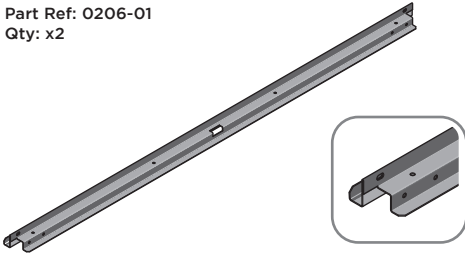

Part Ref: 0206-02  
Qty: x2

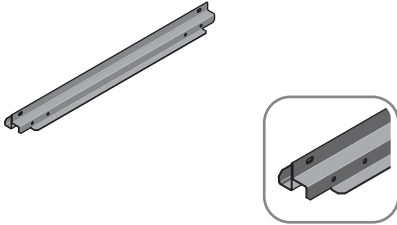

Part Ref: 0206-37  
Qty: x1

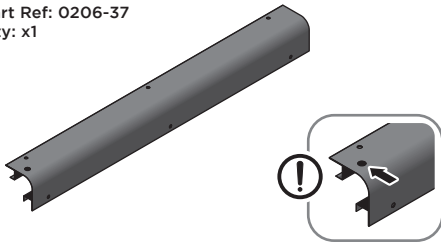

Part Ref: 0206-38  
Qty: x1

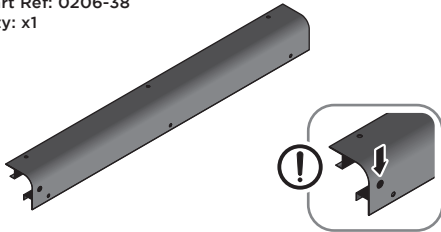

Part Ref: 0206-36  
Qty: x2

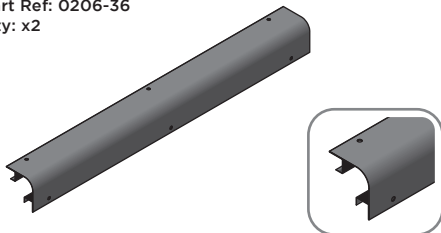

Part Ref: 0206-05  
Qty: x1

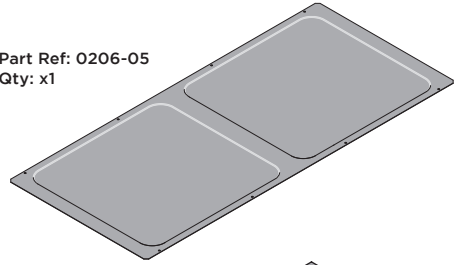

Part Ref: 0206-33  
Qty: x1

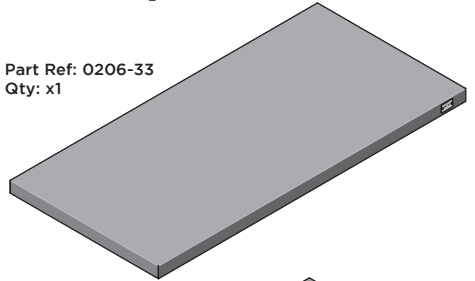

Part Ref: 0206-08  
Qty: x1

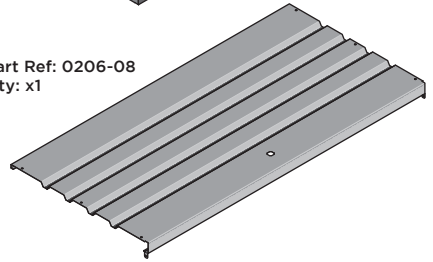

Part Ref: 0206-09  
Qty: x2

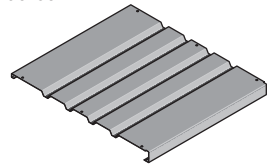

Part Ref: 0206-10  
Qty: x1

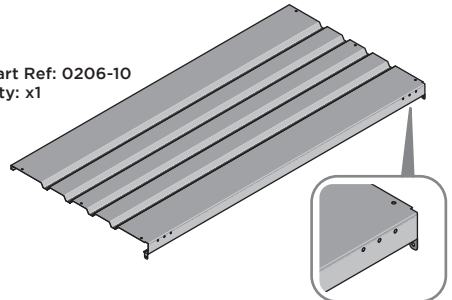

# Parts List

Part Ref: 0206-07  
Qty: x1

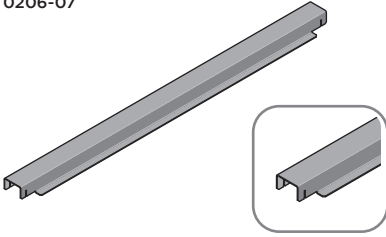

Part Ref: 0203-03  
Qty: x4

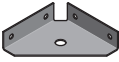

Part Ref: 0206-39  
Qty: x2



Part Ref: 0206-41  
Qty: x1



Part Ref: 0206-29  
Qty: x2

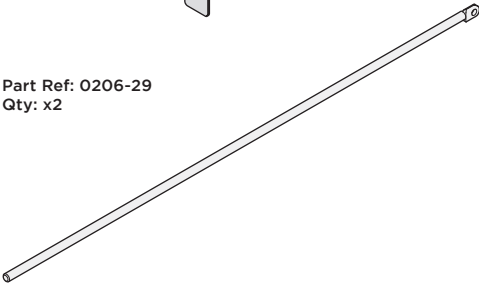

Part Ref: 0206-18  
Qty: x2



Part Ref: 0205-68  
Qty: x4



Part Ref: 0206-19 (Assembly)  
Qty: x1

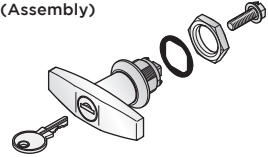

Part Ref: 0206-28 (Assembly)  
Qty: x1

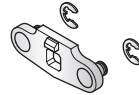

Part Ref: 0204-30  
Qty: x4



FIXING KIT: 0206-31

Part Ref: FK1  
M4 x 8mm Roofing Bolt  
Qty: x63



Part Ref: FK2  
M4 x 12mm C'Sunk Pozi Pan  
Qty: x7



Part Ref: FK3  
M4 Serrated Flange Nut  
Qty: x69



Part Ref: FK4  
M8 Serrated Flange Nut  
Qty: x5



## Caring for your Stone Garden Lifestyle product

Your **Stone Garden Lifestyle** product is designed to stand the test of time, which is why we're happy to offer a **25 year warranty** on our products. With zero maintenance required, simply assemble your **Stone Garden Lifestyle** product and enjoy putting it to great use in your garden.

Periodically, you might want to give your product a clean, these simple care tips are not essential to the performance of your product:

- Remove surface dirt with plain water using a jet wash or sponge, the coating on our products will ensure dirt.
- If you've purchased a **Stone Garden Lifestyle** metal storage solution, periodically clear the roof of fallen leaves.

### Ensure there is adequate clearance where the product is to be located:

Exterior dimensions including overhang (W x D x H)	1355 x 655 x 635mm
Footprint dimensions (W x D)	1305 x 605mm
Clearance required for door to open (W x H)	Doors open outwards 655 x 1200mm

### IMPORTANT: PLEASE REGISTER YOUR STONE GARDEN LIFESTYLE



Doc Ref: 808-3136E Rev.A

## Ensure you have registered your Stone Garden Lifestyle product

Using the unique serial number found on the cover of this document, please visit  
<https://bit.ly/StoneGardenWarranty>  
to register your product and access the 25 year warranty.