

Bramblecrest®

## ASSEMBLY INSTRUCTIONS

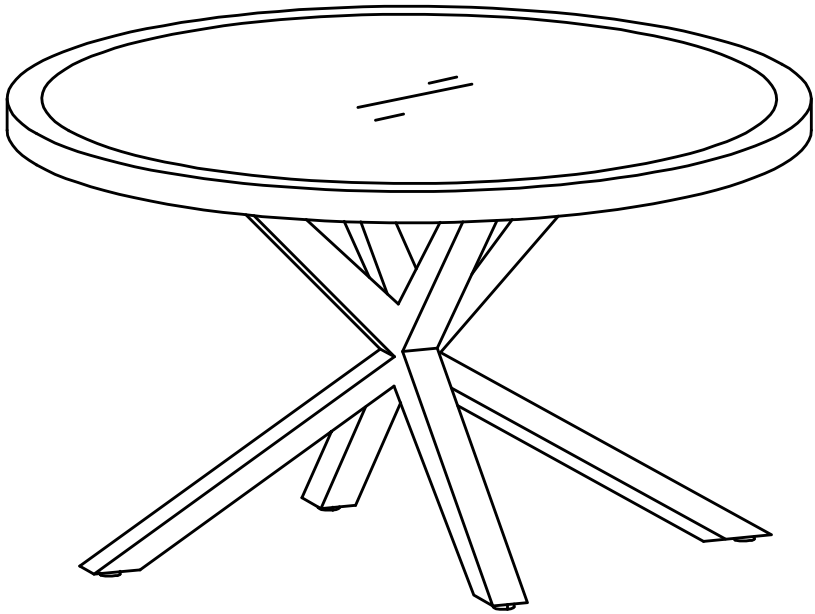

### Morella Round Table

PLEASE KEEP THIS BOOKLET SAFE FOR FUTURE REFERENCE

# THANK YOU

---

Thank you for choosing Bramblecrest garden furniture. These instructions include important information about the assembly, use and care of your furniture. Please take a moment to read through the instructions before beginning the step by step process.

## Assembly advice

- Ensure that two people assemble the product together. Parts can be heavy, especially when lifting glass.
- Power tools are not required to assemble this product. Everything you need for the build is included with the furniture.
- Check that you have all the parts listed before you discard any packaging.
- Assemble the furniture on a non-abrasive surface such as a dust sheet or the original cardboard packaging.
- Do not over-tighten screws.
- Please ensure product is fully assembled before use.
- Keep small parts out of reach of children.
- Make sure all legs are fitted securely and are in contact with the ground.

### Persons required





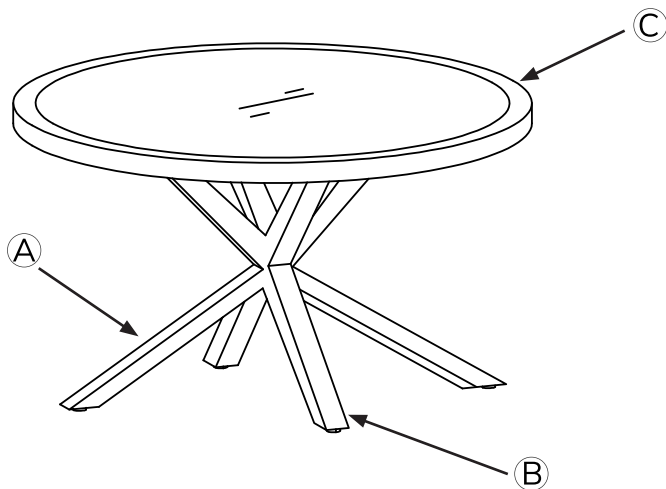
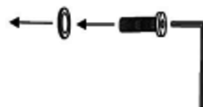



### Tools required

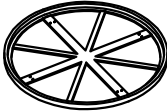
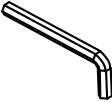

# INVENTORY

---

CODE	PART		QTY
A	Table Leg		1
B	Table Legs		2
C	Table Top		1
D	Allen Key		1
E	Screw M8 50mm		1
F	Washer		1
G	Screws M8 20mm		8
H	Washers		8

# STEP ONE

Turn table legs (A) and (B) upside down so the feet are in the air. Parts (B) come together to meet (A) as shown. Use the M8 50mm screw (E) to secure the legs together making a 'star' formation.

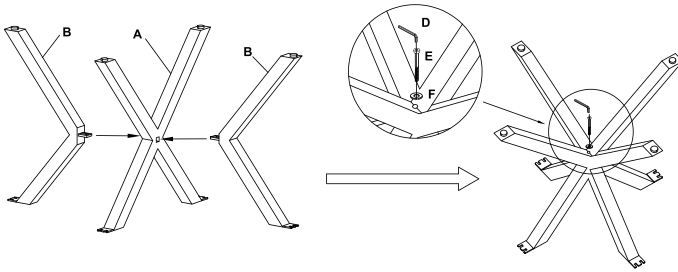

(A) Table Leg  
x1



(B) Table Legs  
x2



(D) Allen Key



(E) Screw M8  
50mm x1



(F) Washer x1



# STEP TWO

Put the table top on a soft surface with the base facing upwards and use the 8 screws and washers (G + H) to attach the legs to the tabletop.

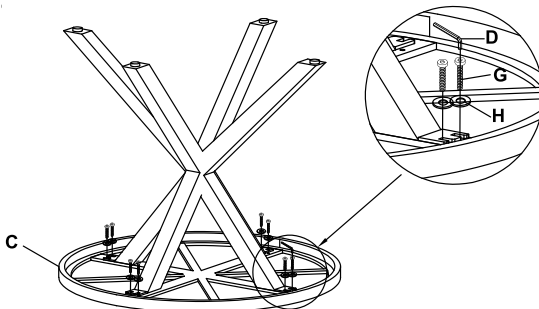

(C) Table Top  
x1



(D) Allen Key



(G) Screws M8  
20mm x8



(H) Washers  
x8



## Your product is now ready for use

The hard work is done and your Bramblecrest furniture is now ready for the great outdoors. To enhance the long term use of your furniture, we suggest that you periodically check it to ensure that all components are in the proper position and free from damage; also make sure connectors are tight and secure. Please keep these instructions for future reference.

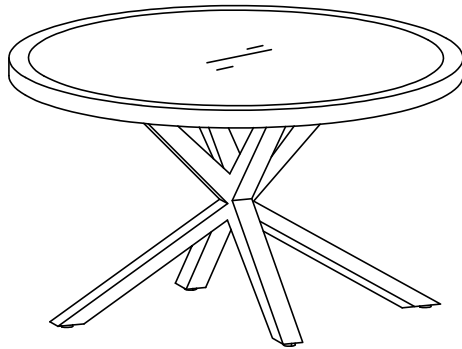

# CARE & MAINTENANCE

---

To uphold the terms and conditions outlined in our guarantee and to maintain the condition of your Bramblecrest furniture, we recommend that you follow the guidance below:

## **Furniture cushions**

- During prolonged periods of non-use or inclement weather, store furniture cushions away in a dry and well-ventilated indoor space. Make sure all cushions are clean and dry when putting them away.
- Complete regular visual checks to inspect for mould, mildew or animal damage.
- Remove spillages immediately with an absorbent sponge or cloth.

## **Table tops**

- Use coasters to protect table tops from heat and water marks.
- Care must be taken when tilting the table to avoid loosening the ceramic or glass surface.
- To avoid permanent stains, clean up spillages immediately.
- To clean the glass or ceramic table tops we recommend the use of any proprietary\* household glass or multi-surface cleaner along with a soft sponge.

## **Rattan & synthetic rope**

- Use a soft brush to clear away any leaves or garden debris. If there are any dirty marks on the rattan, clean with a non-abrasive sponge and lukewarm, detergent-free soapy water. Rinse with fresh water and allow to dry.
- We recommend the use of a Bramblecrest garden furniture cover when your furniture is not in use.

## **Aluminium**

- Clean the frame with a non-abrasive sponge and warm soapy water, rinse with a hose. The aluminium is powder-coated and can be left outside all year with minimal maintenance required.
- We recommend the use of a Bramblecrest garden furniture cover when your furniture is not in use to protect it from garden debris and bird excrement.

## **Parasols**

- Do not leave open parasols unattended. Parasols should be closed and removed when not in use or during adverse weather (windy or gusty conditions).
- Parasols should be closed and covered with a parasol cover when the canopy is dry. During periods of non-use, store away in a dry and well-ventilated indoor space.

## **Teak**

- Teak tables and benches should be left uncovered. Due to the natural properties of teak, the furniture will mellow to a silver-grey colour.
- Remove general surface dirt using warm soapy water and a stiff brush, rinsing off with a hose.

\*Proprietary products are to be used at the discretion of the customer. Bramblecrest does not accept liability or responsibility for any damage caused to the furniture following the use of a proprietary product. Bramblecrest recommend that the customer carefully follows all instructions prior to use

# HELP & ADVICE

---

For any advice about assembling your product, please contact our customer support team with your order number – contact details are shown below.

If you purchased a Bramblecrest product via one of our stockists, please contact them in the first instance to discuss their replacements or returns process.

## What should you do if you encounter a problem?

Any faulty goods must be reported within 24 hours of delivery.

When returning an item that you purchased directly from us, please contact the support team either via email, chat or phone with your order number and they will be able to best advise you with your query.

For full terms and conditions regarding returns and replacements, please visit our website.

Purchases must be registered at [www.bramblecrest.com/registration](http://www.bramblecrest.com/registration) within 28 days of delivery in order to claim your guarantee\*.

---

Email	<a href="mailto:customersupport@bramblecrest.com">customersupport@bramblecrest.com</a>
Telephone	01285 760974 Mon-Fri 9am-5pm
Live chat	Please find the chat button situated in the bottom right of our webpage

---

\*For full terms on our product guarantee, please visit our website.