



POWER SERIES

Premium 700 EC

Category Benefits

This model offers the following benefits:

- Food waste is ground into particles and flushed away
- A convenient solution to food waste in the home
- Lift & Latch Technology makes it easy to install into new or existing kitchens and can be fitted to most sinks

Features

This model offers the following features:

- **0.75 HP induction motor** provides maximum grinding power and durability
- **Reduced sound**
- **Advanced Grind** for tough and fibrous food scraps
- **2-Stage MultiGrind Technology.** Finest grind (Compared to 1-Stage MultiGrind Technology)
- **Removable Baffle**
- Safe for use with properly maintained septic tanks
- Air Switch in Chrome

Warranty

Up to 3-Year Limited Warranty*

* Visit www.insinkerator.com/product-registration for warranty details.

Specifications

Type of Feed	Continuous
On/Off Control	Air Switch
Motor	Single Phase
Motor HP	0.75
Volts	220-240
HZ	50-60
Motor Power, W	380 W
Time Rating	Intermittent
Lubrication	Permanently Lubricated Upper & Lower Bearings
Shipping Weight (Approx.)	8.12 kg
Overall Height	31.2 cm
Motor Protection	Automatic Reset
Drain Connection	3.8 cm Cushioned Slip Joint
Dishwasher Drain Connection	Yes
Grind Technology	2-Stage MultiGrind Technology
Plug	3pin UK
Grind Chamber Capacity	980 ml

Dimensions

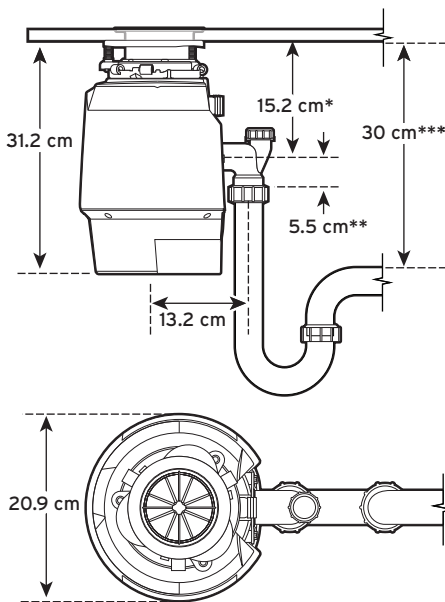

*Distance from bottom of sink to centre line of disposer outlet. Add 12.7 mm when stainless steel sinks are used.

**Length of tailpipe from centre line of disposer outlet to end of tailpipe.

***Distance between bottom of sink bowl to the waste pipe to be minimum of 30 cm.

