



User Manual

piqo

Welcome to

piqo

Follow this guide to get started with your new Nextbase Piqo Dash Cam.

Or go to

nextbase.com/piqo-install

for more information on Piqo and the entire

Nextbase experience. Please be sure to view the installation videos for setting up and using your Nextbase Piqo Dash Cam.



Meet Nextbase Piqo. It's a small & mighty Dash Cam for your vehicle. Compact, high-definition and always on guard. On the move, or parked, Piqo protects. It's the perfect companion for the roads with 1080p or 1440p recording, fine-tuned and optimised to capture the key details, while its sleek and small design makes it almost invisible in your vehicle. The all-new Nextbase App ensures a seamless connection to access, edit and share footage easily providing you with the best Dash Cam experience.



Do NOT interact with your Piqo while driving. Distractions while driving can lead to serious injuries.



For Your Safety

Please read this guide before setting up or using your Nextbase Piqo Dash Cam. Your health and safety are our priority, failure to follow these instructions could lead to injury and a poor user experience.

- Use your Piqo as instructed in this guide.
- Do not interact with your Piqo while driving, distractions while driving can lead to serious injuries.
- Do not mount your Piqo in front of the driver, Piqo must not obstruct the drivers line of sight. Mount outside sight-lines to the roads, highway signs and signals.
- When installing Piqo in a vehicle, always place the device securely against the windscreen and where possible conceal the power cable under trim.
- Make sure that the Dash Cam power cable does not interfere with the driver's operating controls, such as the steering wheel, pedals or gear levers.
- Do not mount the Dash Cam in front of an airbag field of deployment or in a position to obscure any mirrors.
- Clean the windscreen at the point of location, prior to fitting the Dash Cam
- Download the Nextbase App to use your Piqo and ensure you enable all permissions as these are required for your Dash Cam and Nextbase App to work.

Have some questions?

Click here for more useful information, FAQs and videos

More Piqo Info



Contents

03

Welcome 02

For Your Safety 03

Box Contents 05

Overview

How a Dash Cam works 06

Dash Cam parts 07 - 08

Installation 09 - 14

Features

Library, Downloads & Playback 15

Voice Commands / Smart Parking 16

Guardian Mode lite / Witness Mode Lite 17

Nextbase Protect Subscription 18

LEDs 19

App Settings 20

Accessories 21

Glossary 22

Compliance 23 -24

Maintenance Tips 25



Box Contents

05

Spare 3M Mount

Use the spare 3M pad when you switch vehicles to continue using your Piqo or keep it as a backup.

Fitting Tool

Use the tool to pry open the vehicle lining to stow the power cable. The power cable should not obstruct the view of the driver.



Dual type-C 12V adapter and 4m (13.1ft) power cable

Car Adapter with two USB-C ports allow you to power your Piqo as well as another USB-C device via your vehicle's 12V plug.

Piqo Camera

Front facing camera to record the road ahead of your vehicle.

Also included

Cleaning Pack

Use the kit to clean your vehicle's windscreen prior to installation to ensure the best adhesion for the mount.

Window Stickers

Protected by Nextbase and Road Safety Club stickers letting others know your vehicle is fitted with a Dash Cam.



Overview

How a Dash Cam works

Camera

Your Piqo has a front facing camera to keep an eye on the road ahead.

Power Source

When connected to your vehicle using the 12V car Adaptor, Pro Install Cable* or Piqo Quick Connect Cable*, your Piqo automatically turns on and starts recording when the engine starts.

Recording

The camera continuously records video footage while you're driving. Video is recorded in short segments, a minute long, to make it easier to manage the files.

Storage

Recorded video footage is stored on an SD card inserted into your Piqo. The SD card acts as storage, similar to an SD card in a digital camera.

Nextbase App

The all-new Nextbase App ensures a seamless connection to access, edit and share footage easily. Cutting edge features such as Emergency SOS and driver data are included to give you the best Dash Cam experience. Search for 'Nextbase App' in the app store.

Loop Recording

As the memory card fills up with recorded video, your Piqo uses a feature called "Loop Recording" to overwrite the oldest footage with new recordings. This ensures that the camera can keep recording even when the memory card is full. Important files should be manually saved to prevent them from being overwritten.

Event Recording

Your Piqo has built-in G-Sensors which detect sudden movements or impacts to your vehicle. When an event like a collision or sudden braking is detected, your Piqo will automatically save the footage surrounding the event and mark it as an important file to be reviewed.

Playback and Accessing Footage

To view the recorded footage, use the Nextbase App (recommended) or use a USB-C data cable* to connect your Piqo to your computer. Alternatively, you can use the SD card with a card reader on your computer. Once the footage is accessed, you can review, edit, or share the recordings as needed.



Overview

Dash Cam Parts

USB-C Connector

Connect the power cable here.

Adhesive Mount

Peel off the adhesive backing when you are ready to attach your Piqo to your windscreen.



Lens

Adjust the camera so the lens is pointing straight out of the front windscreen. Ensure the area in front of the lens is clean and free of scratches. Ensure not to damage the lens as this may affect recording quality. Your Piqo should not obstruct the view of the driver.



Overview

Dash Cam Parts

SD Card slot

Insert an SD card into the SD card slot to allow Pigo to record video.

Speaker

Sounds for actions such as power on, and start/stop recording. Device sounds can be turned off by accessing the Dash Cam settings in the Nextbase App.



Protect Button

During regular driving, press the Protect Button to protect the recording. This means it won't be automatically overwritten so you can review the footage later.

Microphone

Used for Voice Commands.



Installation

Dash Cam setup

Notes Before Installing

Before getting started, make sure you have the following to hand:

- The contents of the box
- Your car keys
- Your mobile device
- Download Nextbase App

Search for 'Nextbase App' in your device's app store or click the app store icon for your mobile device to be taken directly to the app.



GET IT ON
Google Play



Download on the
App Store

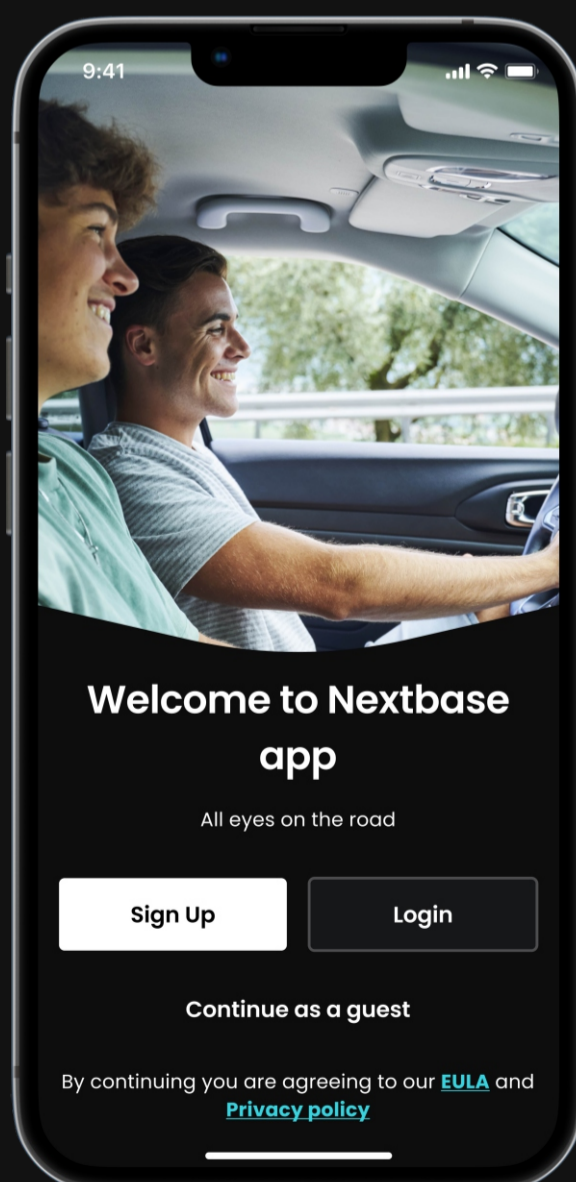

Installation

Dash Cam setup

10

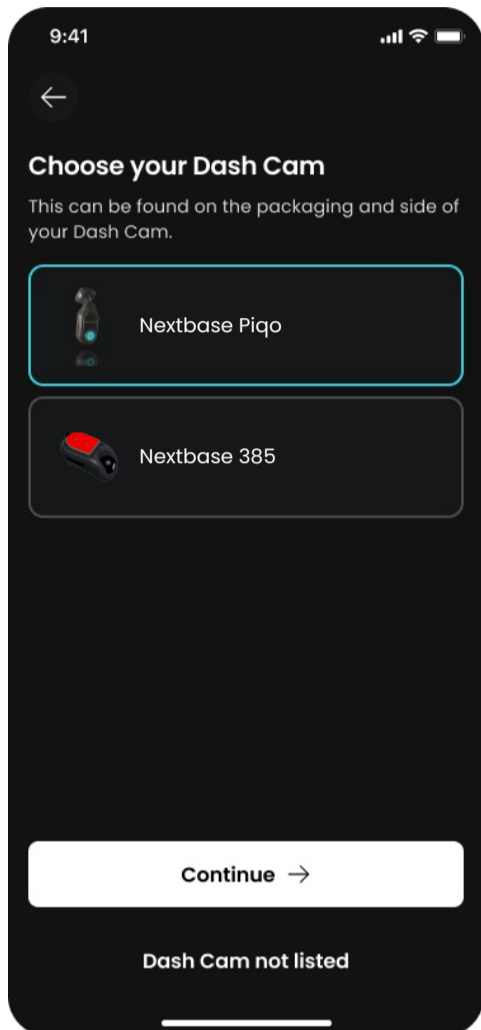

1 Follow the In-App Setup Instructions

Upon opening the Nextbase App, create an account and select Piqo. These steps are also listed in this installation guide.

2 Insert SD card

Insert the SD card into the slot. Ensure the SD card is inserted the correct way matching the orientation shown. For best performance, we recommend using a Nextbase SD card.

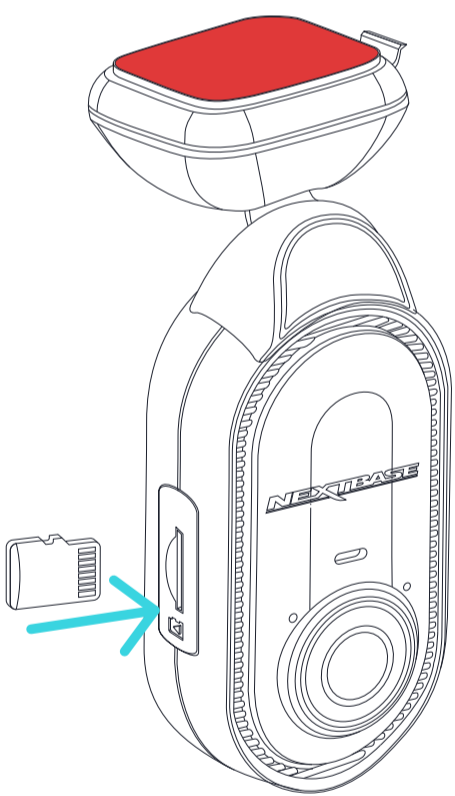

3 Power your Piqo

Plug the angled end of your power cable into your Piqo. Plug the other end of your power cable into the dual type-C 12V adapter. Don't mount your Piqo yet.

Turn on your vehicles ignition to power Piqo. You should see a blue light on your Piqo when the power is connected.

If your Piqo does not turn on, ensure all of the power cables are correctly connected.

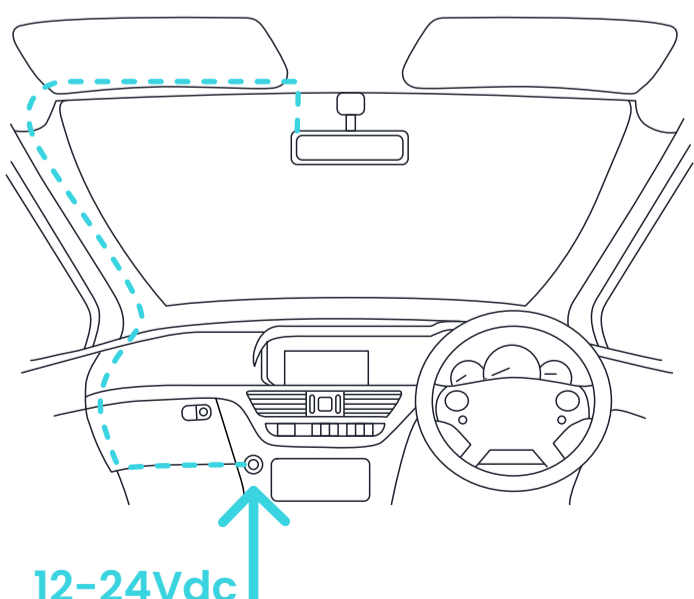

The above diagram is for illustration purposes only.



Installation

Dash Cam setup

11

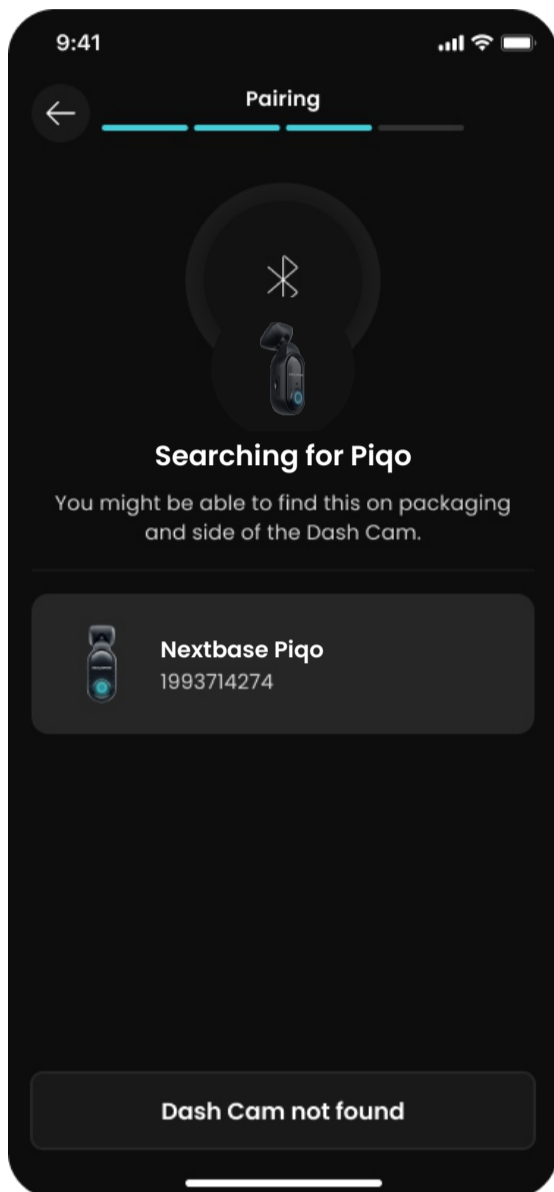

4 Pair Piqo to the Nextbase App

Ensure you allow all the required permissions in the Nextbase App. This ensures that your Piqo and the Nextbase App will work as expected.

Put your Piqo into pairing mode by holding down the power button for 5 seconds. Your Piqo will pulse blue when pairing mode is activated and the device is discoverable.

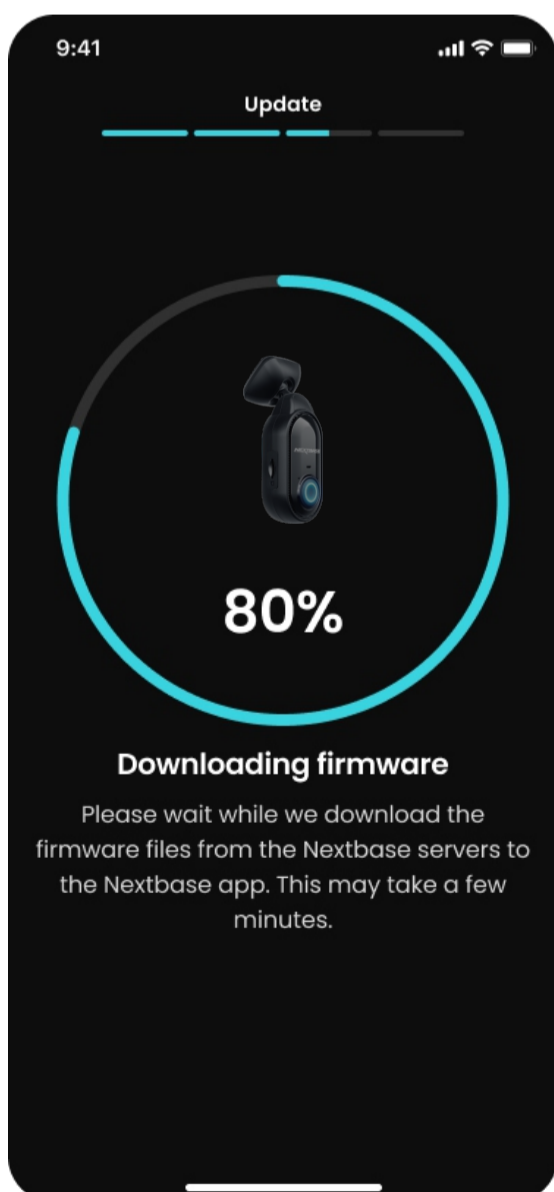

5 Update your Piqo Firmware

Once you've paired your Piqo and the Nextbase App, check for available firmware updates. Firmware updates bring the latest features to Piqo so its important to stay up to date.

We'll create a high speed Wi-Fi connection between Piqo and your mobile device in order to update the Piqo firmware.



Installation

Dash Cam setup

12

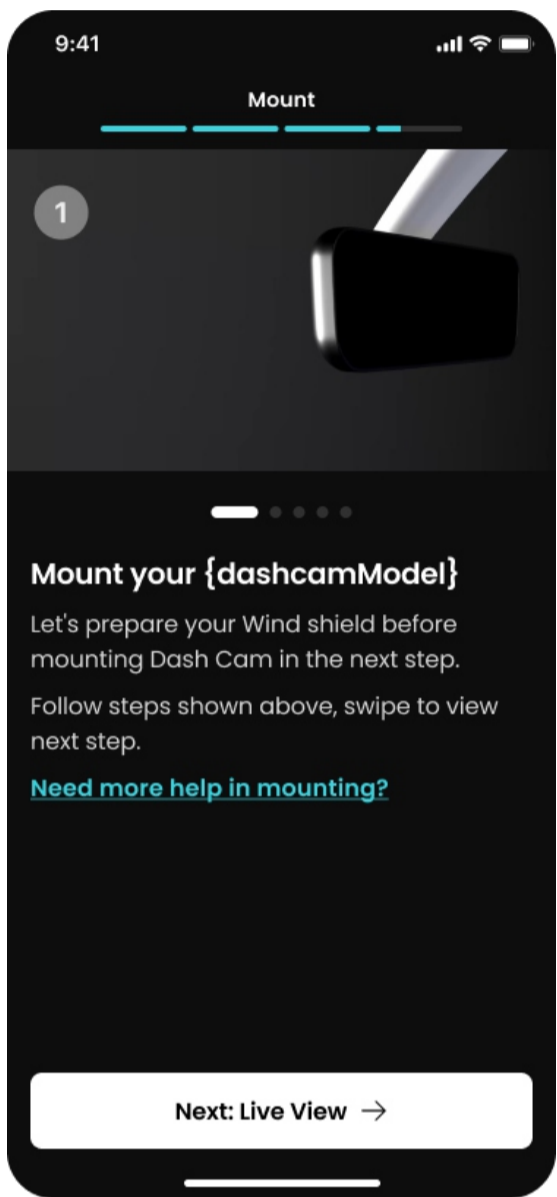

6 Clean the area of the windscreen to which you will mount your Piqo

Clean the area of the windscreen to which you will mount your Piqo ensuring the windscreen is clear of grease and dirt. Point the lens out of the wiper zone for clear recordings in all weather conditions.

- 1) Use the wet wipe (green) to clean the windscreen
- 2) Use the dry wipe (pink) to dry the windscreen

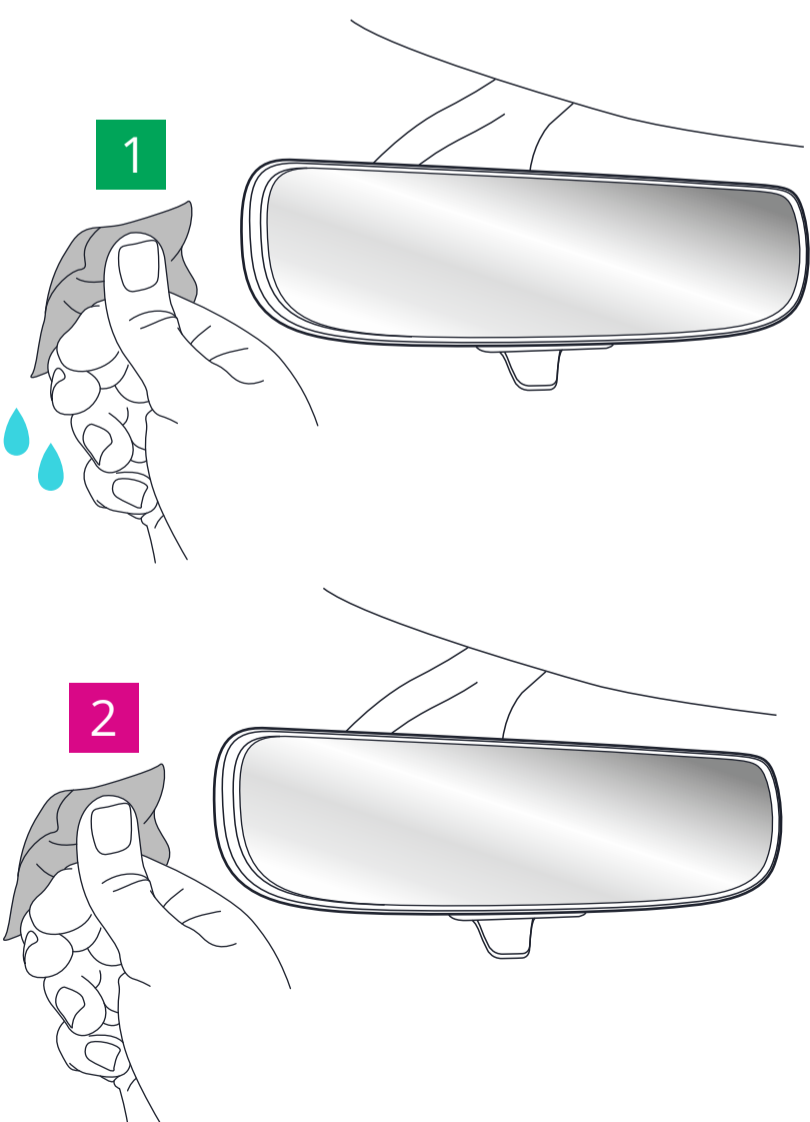

Having trouble installing your Piqo?

Click here for a video walkthrough

[Installation Video](#)



Installation

Dash Cam setup

13

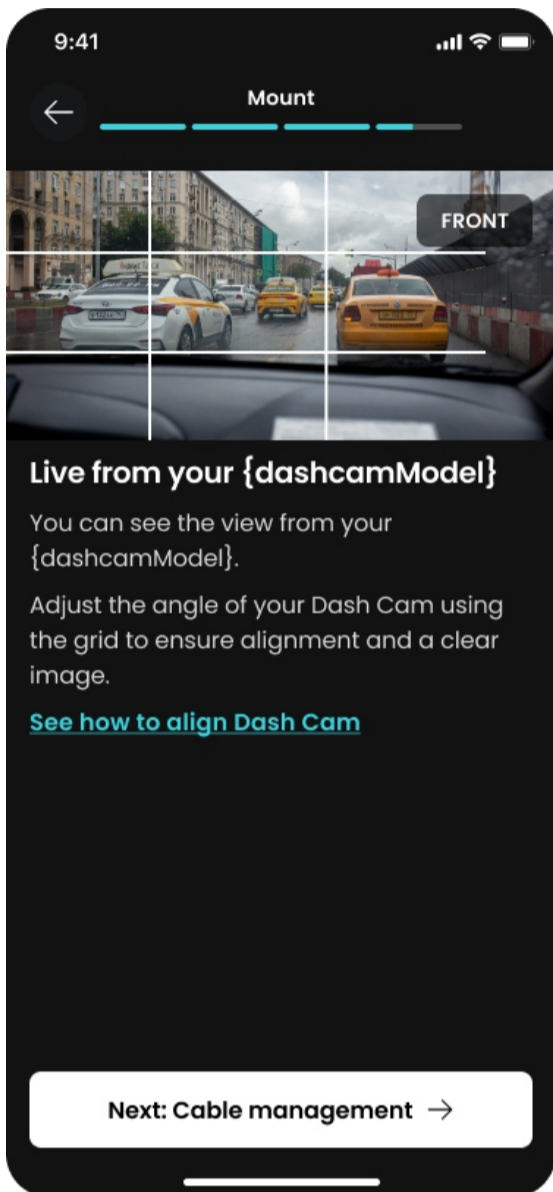

7 Mount your Piqo

With Piqo connected to the app you'll be able to see the Dash Cams Live View. Use this to help find the best place to position your Piqo.

Once you're happy with the placement of your Piqo, remove the 3M adhesive backing.

Firmly press the adhesive pad to the clean area of the windscreen. Press for up to 30 seconds to ensure a strong bond between the pad and windscreen.

Make any final adjustments using live view in the app.

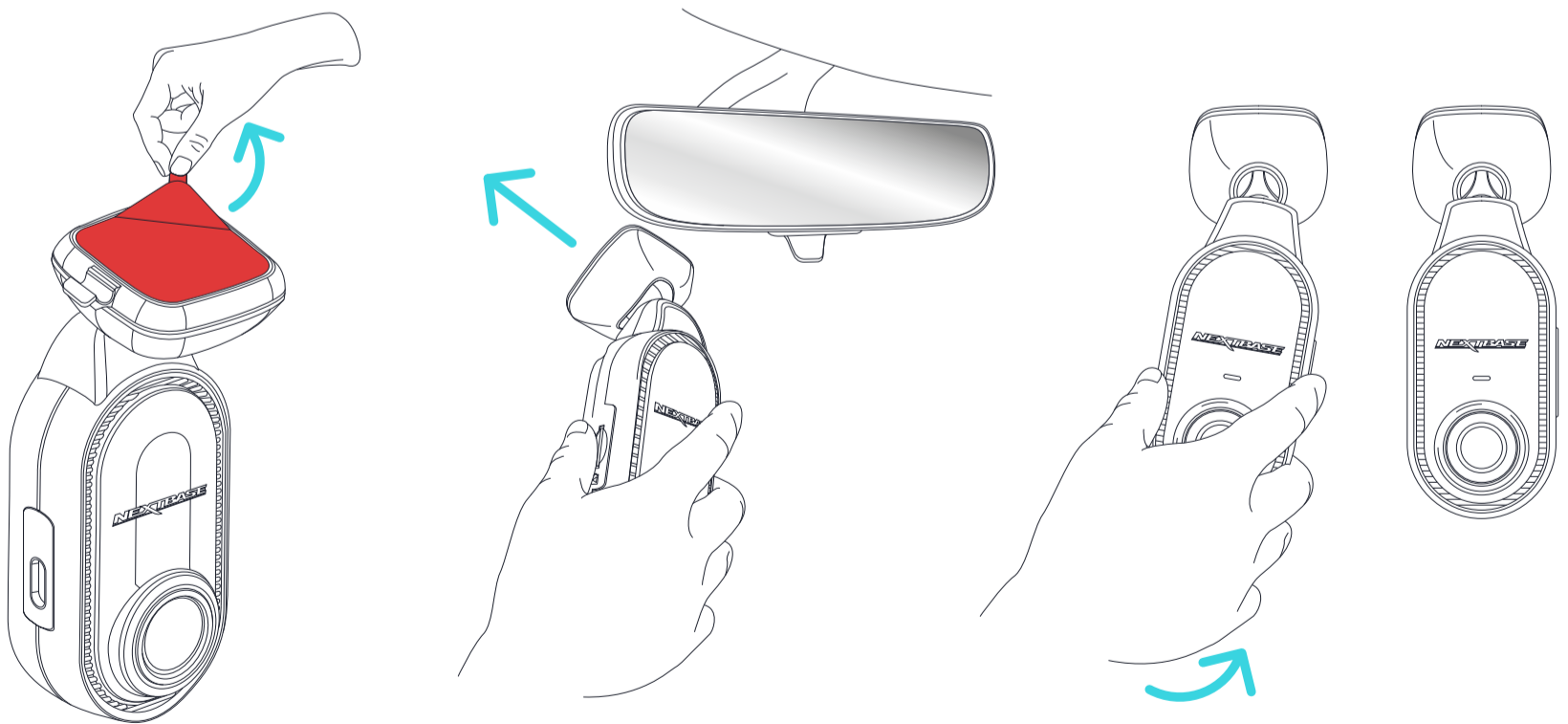

Piqo must NOT obstruct the driver's line of sight. Mount outside sight-lines to the road, highway signs, and signals.



Installation

Dash Cam setup

14



8 Cable Management

Route your power cables neatly around your windscreen and tuck into the lining of your vehicle to stop any loose wires distracting the driver. Use the cable tidy tool.

Ensure you tuck the power cable into the lining of your vehicle to stop any loose wires distracting the driver. Use the fitting tool (supplied with your Piqo) to help tuck the cable away.

⚠ Warnings

Make sure that the Piqo power cable does not interfere with the drivers operating controls, such as the steering wheel, pedals or gear levers. Do not mount Piqo in front of an airbag field of deployment or in a position to obscure any mirrors.

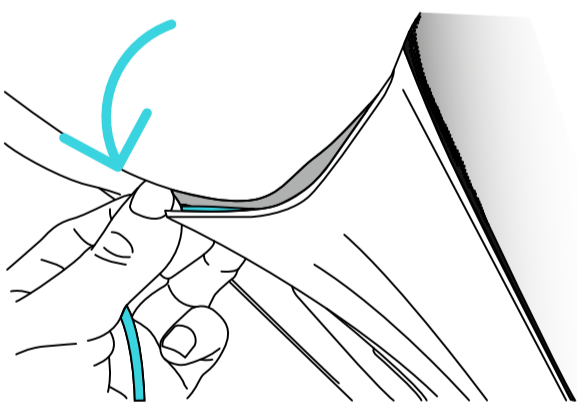
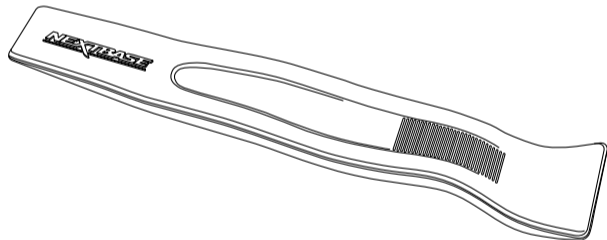

9 Mounting Tip

If you need to remove your Piqo device from the windscreen, slide the Dash Cam off the mount.



Library, Downloads & Playback Feature

Effortlessly view, download and share videos from your Piqo in the Nextbase app. Connect to your Piqo via Bluetooth and enter the library screen, we'll then create a high speed Wi-Fi connection between your Piqo and Nextbase app. Once connected you can scroll through all of the videos currently stored on the SD card. The protected video carousel shows videos that:

- Piqo has automatically protected using our G-Sense+ technology
- You have manually chosen to protect
- Are Witness or Guardian mode recordings.

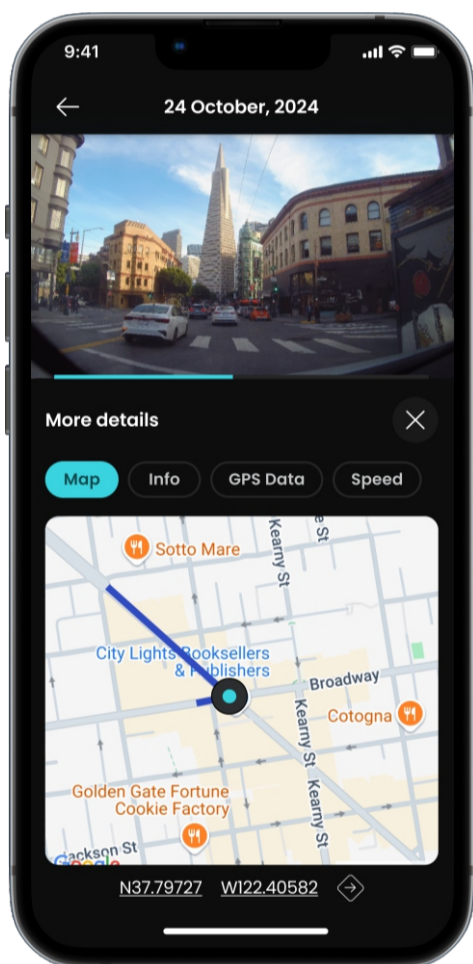

When you select a video to watch you'll be guided to the Playback screen. Here you can watch your video and see key data such as speed, location, g-force and more! Use the carousel to share, download, protect and delete videos.

When you download a file from your Dash Cam, make sure your car ignition is on and you are near your Piqo. Once your download has completed files will show in the Downloads tab of the Nextbase app.

Once you have downloaded a video you can share it via social media. Make sure you tag Nextbase!

Finally, every Nextbase app user gets 30 days of MyNextbase Cloud storage! From the Playback screen upload your video to the MyNextbase Cloud and get a shareable link for you to share your video. You can also password protect the link for extra security.



Voice Commands Feature

16

Your Pigo Dash Cam has a number of features that can be activated by voice commands. See below the full list of voice commands available:

HEY NEXY, PROTECT

HEY NEXY, WITNESS MODE

HEY NEXY, STOP WITNESS MODE

HEY NEXY, PRIVACY MODE

HEY NEXY, STOP PRIVACY MODE

Smart Parking Feature

Tired of door dings and parking lot love taps to your bumper? Pigo's Smart Parking feature has you covered. It automatically records any hits or knocks while you're away, then sends you an alert when you return to your vehicle.

To activate this helpful feature, just pair it with the Pigo Pro Install or Quick Connect cable—sold separately. Can be purchased at nextbase.com.

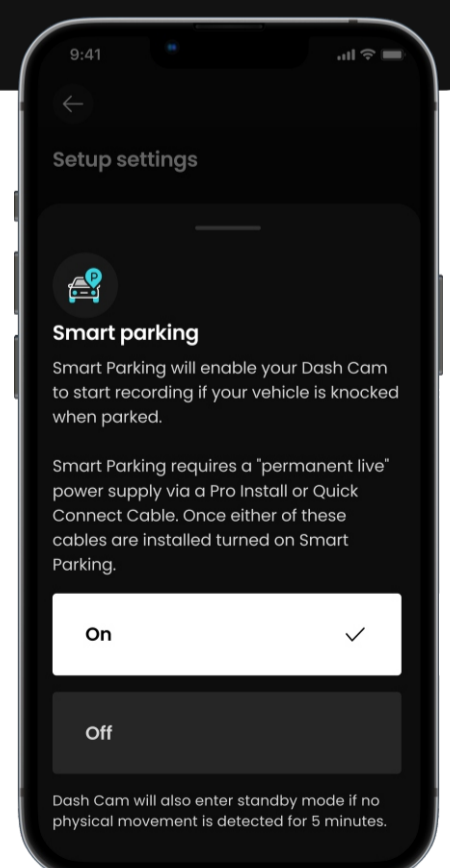

Guardian mode LITE Feature

17

Child, friend, mechanic or valet using your vehicle? Set fixed speed or geolocation limits and protect your vehicle, even when you are not there. If a speed or location limit is broken, then you will be notified as soon as you get back to the vehicle. The evidence will be saved onto the Nextbase app.

Set your emergency contacts to receive an SMS and email when an speed or location alert is broken in the Nextbase app, these will be sent when your Piqo is connected to the Nextbase app via Bluetooth.

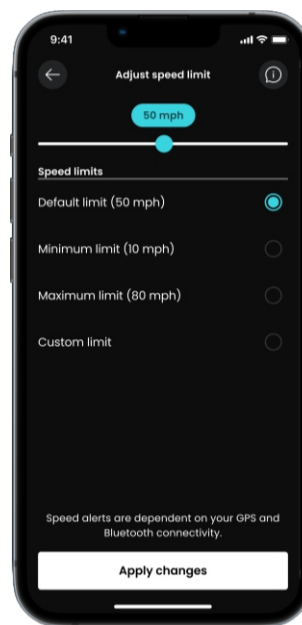
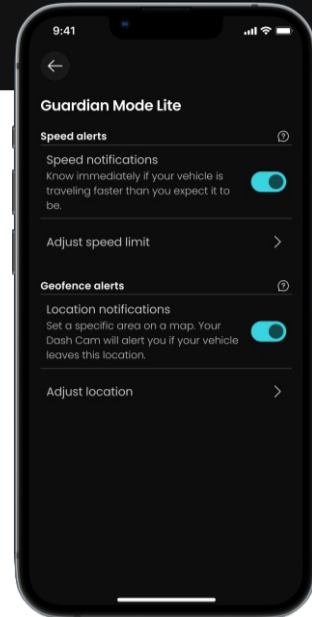

Witness mode LITE Feature

Feeling uneasy on the road? Whether it's road rage or a bad situation, Piqo's Witness Mode Lite is here for you. Just say:

“Hey Nexy, Witness Mode”

and your Piqo sends an instant SOS text to a friend or loved one, letting them know you need help.

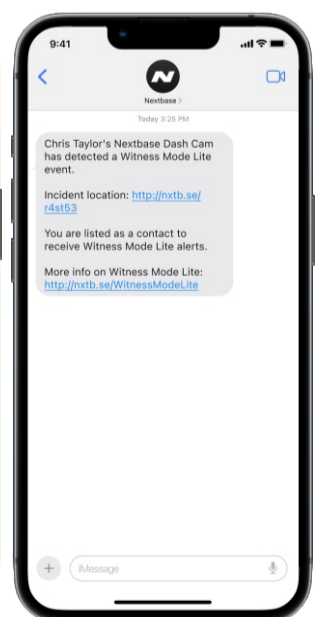
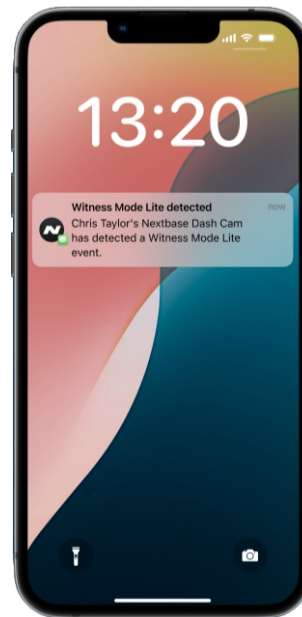

Set your emergency contacts to receive an SMS and email when a Witness Mode event is triggered in the Nextbase app, these will be sent when the Dash Cam is connected to the Nextbase App via Bluetooth.

Witness Mode recording can be stopped by saying “Hey Nexy, stop Witness Mode”.



Nextbase Protect Subscription Feature

Emergency SOS

In a serious accident, Piqo's Emergency SOS is a real lifesaver—literally. This feature automatically contacts emergency services, sharing your exact location and vital details to help them get to you fast. It's peace of mind in your pocket.

More information here:

nextbase.co.uk/emergency-sos-feature

180 days MyNextbase Cloud storage

Extended your MyNextbase Cloud storage with the Nextbase Protect Subscription.

Additional 24 months warranty

Start your 1 month free trial now!
Sign up in the Nextbase app.

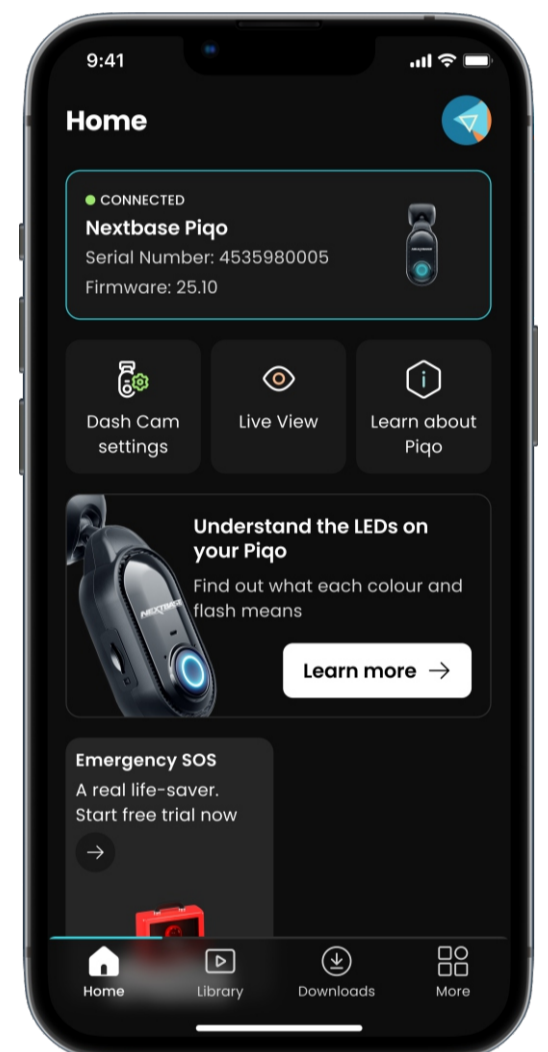

Have some questions about Piqo features?

Click here for more useful information, FAQs and videos

More Piqo Info



LEDs

Actions and colours

The ring light on your Piqo shows different colours and behaviours to display its functions. Use this guide if you are unsure what the lights mean.



	Solid	Pulse	Flash	Fade In	Fade Out
BLUE	Power On, NOT Recording	Bluetooth Pairing	Bluetooth Pairing Failed	Power On	Power Off
RED		Normal Loop Recording	Recording Protected File		
RED / BLUE			ESOS Active		
RED / WHITE			ESOS Error		
YELLOW		Firmware Installing	Clearing SD Card		
WHITE		Voice Command Recognised			
ORANGE	No SD Card Detected		SD Card Error		
GREEN	Connected to Computer	Wi-Fi Connected			
PURPLE		Witness Mode Active			



Settings In the app



These Settings can be changed in the app.

Resolution

The level of detail captured. Higher resolutions mean larger file sizes

Exposure

Determines how light/dark your recorded image is

Audio

Toggle sound recording On/Off

Time Stamp

Information overlaid onto your videos can be toggled On/Off

Speed Stamp

Information overlaid onto your videos can be toggled On/Off

GPS Stamp

Information overlaid onto your videos can be toggled On/Off

Model Stamp

Information overlaid onto your videos can be toggled On/Off

Number Plate

Input your number plate to have it appear on your video.

Impact Sensitivity

Adjust the sensitivity of the G-Sensor, which will change the threshold to trigger automatic file protection.

Limited History

Maximum – no recording restrictions

Minimum – Total unprotected video recording is limited to comply with some non-UK laws.

Check your local laws.

Smart Parking

With Parking Mode On, the Dash Cam will record a video if the G-Sensor is triggered while your vehicle is parked and turned off.

Language

Change the language that voice announcements are made in.

Time & Date

Adjust the time & date as required.

Note: Time and date settings will be over-written upon satellite connection.

Speed Units

Choose between MPH & KMH

Device Sounds

Turn On/Off the startup and shutdown sounds.

System Info

Show your Dash Cam's Information, such as firmware version, serial number.

Format SD Card

Clear the SD card of all files. Ensure you back up any files you want to keep before formatting the SD card.

Reset to Default

Reset the Dash Cam to default settings.

Emergency SOS

Set up Emergency SOS in the Nextbase App.

In the event that leaves you unable to call for help, the Dash Cam will register a serious incident and tell the app to call the emergency services to your location.

This call to the emergency services can be canceled using the app if you find that you do not need emergency attention.



Accessories

Available for your Piqo



Piqo Pouch

Featuring a durable, rigid shell, this pouch is built to keep your Dash Cam in top condition.

Piqo Car Power Cable

Plug it into your vehicle's 12-volt socket. The dual USB-C ports allow you to charge your dash cam and another device simultaneously.



* Smart Parking is NOT supported with this power option.



Piqo Pro Install Cable

Offers seamless hardwiring to your vehicle's fuse box for both 12-volt and 24-volt vehicles. Easily enable Smart Parking & the built-in voltage limiter protects your vehicle's battery, ensuring your dash cam operates safely and consistently.

Quick Connect Cable

Fast and easy way to power your Dash Cam through your vehicle's OBD port. Offering a permanent live connection, it's perfect for activating Smart Parking.



Dash Cam

Also known as a dashboard camera, a Dash Cam is a video recording device mounted on the windshield of a vehicle to capture video footage. Piqo includes a front facing camera.

Mount

The mount is the part that adheres directly to the windscreen (or rear window for a Rear Camera).

The Mount attaches to the Camera body. The Piqo can be removed from the mount by sliding the Piqo away from the mount.

Loop Recording

The Dash Cam records continuously by overwriting older footage when the storage capacity is full.

Loop Recording ensures that the camera always has the latest footage available.

Emergency SOS

When Emergency SOS is set up, in the event of an incident that leaves you unable to call for help, Emergency SOS will contact emergency services to your location to assess the situation and assist where necessary. Emergency SOS can be set up using the app.

microSD Card

Piqo uses a microSD card for storage. The card's capacity determines how much footage can be stored before looping begins. It's important to use Nextbase-branded, high-quality, high-capacity cards that are compatible with your Piqo. It is important that this SD Card is not removed during recording, or forced into the slot, as this could damage the SD Card or the SD Card reader in the Piqo.

Resolution

Refers to the clarity and sharpness of the video footage recorded by your Dash Cam. The higher the resolution, the more detail in the video, and the larger the file size.

Field of View

Also known as a dashboard camera, a Dash Cam is a video recording device mounted on the windshield of a vehicle to capture video footage. Piqo includes a front facing camera.

G-Sensor

A built-in sensor that detects sudden changes in motion or impact. If Parking Mode is turned On, an event will be recorded if the G-Sensor levels pass a predetermined threshold. G-Sensor data is also recorded along with video feeds.

LED

Light Emitting Diode; Piqo has LEDs to signify different functions and processes by displaying various colours through the light ring.

Event Recording

Your Piqo has built-in G-sensors which detect sudden movements or impacts. When an event like a collision or sudden braking is detected, Piqo will automatically save the footage surrounding the event and mark it as an important file to be reviewed.

Pro Install Cable

A Pro Install Cable allows you to connect Piqo directly to your vehicle's fusebox allowing you to free up the 12V socket in your vehicle. Connecting to your vehicle's permanent live and enabling parking mode allows Piqo to record footage even when the car is off. An installation guide is included with the Pro Install Cable, once purchased.

App

Download the latest Nextbase App for more features. When connected, you can instantly view the videos on your Dash Cam through the app, as well as edit and share clips.

Live View

Live View is an app feature which allows you to view the camera feed in real time, handy when setting up the Dash Cam, to make sure the view is clear.



Product Compliance Information

Warranty Information

Please see our returns and warranty policy at nextbase.co.uk/help-and-support/warranty-information

Product Wireless Information

2400–2483.5 MHz: Wi-Fi (Max 15.9 dBm), BT (Max 3.3 dBm)

ACMA RCM Notice to Users in Australia & New Zealand

Having had regard to documents submitted, our Authorised Agent (EMD AUSTRALIA PTY LTD RCMC24101402D) is satisfied that the in-vehicle accessory products NBPICO1 & NBPICO2 comply with the requirements of the relevant ACMA Standards made under the Radiocommunications Act 1992 and the Telecommunications Act 1997. The full compliance declaration, including the details of the applicable standards and documents submitted can be found on our website at <https://www.nextbase.com/certifications>

CE

Hereby, Portable Multimedia Limited declares that the radio equipment type NBPICO1 & NBPICO2 Dash Cam is in compliance with Directive 2014/53/EU. The full text of the EU declaration of conformity is available at the following internet address: <https://www.nextbase.com/certifications/>

UKCA

Hereby, Portable Multimedia Limited declares that the radio equipment type NBPICO1 & NBPICO2 Dash Cam is in compliance with UK Regulation S.I. 2017 No. 1206. The full text of the UKCA declarations of conformity are available at the following internet address: <https://www.nextbase.com/certifications/>

Product Disposal



The crossed out wheellie bin symbol indicates that according to EU and UK laws and regulations your Piqo and / or its accessories shall be disposed of separately from general household waste. When Piqo reaches the end of its life, please take it to an appropriate collection point. The collection point will be specified by your local authority.

Separating Piqo from general waste at the end of its service life will help conserve natural resources and ensure that Piqo is recycled in a way that protects human health and the environment.

RF Exposure Information (MPE)

This device meets the EU requirements and the International Commission on Non-Ionising Radiation Protection (ICNIRP) on the limitation of exposure of the general public to electromagnetic fields by way of health protection. To comply with the RF exposure requirements, this equipment must be operated in a minimum of 20 cm separation distance to the user.

RF Exposure Statement FCC

This equipment complies with the FCC RF radiation exposure limits set forth for an uncontrolled environment. This equipment should be installed and operated with a minimum distance of 20cm between the radiator and any part of your body.

FCC Statement:

This device complies with Part 15 of the FCC Rules. Operation is subject to the following two conditions

- (1) the device may not cause harmful interference, and
- (2) the device must accept any interference received, including interference that may cause undesired operation.

This equipment has been tested and found to comply with the limits for a Class B digital device, pursuant to Part 15 of the FCC Rules. These limits are designed to provide reasonable protection against harmful interference in a residential installation. This equipment generates, uses and can radiate radio frequency energy and, if not installed in accordance with the instructions, may cause harmful interference to radio communications. However, there is no guarantee that interference will not occur in a particular installation. If this equipment does cause harmful interference to radio or television reception, which can be determined by turning the equipment off and on, the user is encouraged to try to correct the interference by one or more of the following measures:

- Reorient or relocate the receiving antenna.
- Increase the separation between the equipment and the receiver
- Connect the equipment to an outlet on a circuit different from that to which the receiver is connected.
- Consult the dealer or an experienced radio/TV Technician for help.
- This appliance and its antenna must not be located or operated in conjunction with any other antenna or transmitter.
- A minimum separation distance of 20cm must be maintained between the antenna and the person for the appliance to satisfy the RF exposure requirements

FCC Caution

This product does not contain any user serviceable parts. Repairs should only be made by an authorised Nextbase™ service centre. Unauthorized repairs or modifications could result in permanent damage to the equipment, and void your warranty and your authority to operate this device under Part 15 regulations.

FCC Identifier and ISED Certification Number

The device meets the FCC Radio Frequency Emission Guidelines and is certified with the FCC. Information about this product is on file with the FCC and can be found by inputting the Product's FCC ID (available on the product gift box and as an e-label accessible as per the information given above) into the FCC ID. Search form available at: <https://www.fcc.gov/oet/ea/fccid>

The party responsible for FCC compliance is:

Portable Multimedia Limited, 230 Blackfriars Road, London, England, SE1 8NW

To contact Nextbase about the device's FCC equipment authorization, please write us at the address shown above or contact us using the following address: compliance@nextbase.co.uk

IC Warning

This device complies with Industry Canada license-exempt RSS standard(s). Operation is subject to the following two conditions:

- (1) this device may not cause interference, and
- (2) this device must not accept any interference, including interference that may cause undesired operation of the device.

Le présent appareil est conforme aux CNR d'Industrie Canada applicable aux appareils radio exempts de licence. L'exploitation est autorisée aux deux conditions suivantes:

- (1) l'appareil ne doit pas produire de brouillage, et
- (2) l'utilisateur de l'appareil doit accepter tout brouillage radioélectrique subi, même si le brouillage est susceptible d'en compromettre le fonctionnement.

This device has been evaluated to meet general RF exposure requirement. To maintain compliance with RSS-102 - Radio Frequency (RF) Exposure guidelines, this equipment should be installed and operated with a minimum distance of 20cm between the radiator and your body.

Le dispositif a été évalué à répondre général rf exposition exigence. Pour maintenir la conformité avec les directives d'exposition du RSS-102 - Radio Fréquence (RF). Ce matériel doit être installé et exploité à une distance minimale de 20cm entre le radiateur et votre corps.



Compliance

Warnings & Cautions

SAFETY

Please read safety and health information carefully before you install your iQ so that you can ensure its safe and proper operation in your vehicle.



Failure to follow these guidelines may cause harm to your device, your property, your health or the health of others.

WARNING

Failure to correctly install Piqo may present hazards for the safe operation of your vehicle and could contribute to an accident resulting in serious injury, death or damage to property for you, your passengers or others. When installing this device in your vehicle;

- You must correctly locate Piqo on your windshield. Mounting Piqo in a position that obscures the forward line of sight for the driver of your vehicle may cause the driver of your vehicle to be unable to adequately see other road users, obstacles or persons around your vehicle. This could result in an accident that causes serious injury, death or property damage. Carefully follow the mounting instructions in your app and in the installation section of this manual.
- You must adequately secure Piqo to your windshield. The 3M pad supplied with your Piqo consists of a pressure activated tape. If an inadequate bond is achieved whilst fitting Piqo may separate from the windshield. If this occurs whilst the vehicle is being driven, it could become a restriction to safe operation of your vehicle leading to an accident that causes serious injury, death or property damage. Stop your vehicle as soon as it is safe to do so and disconnect Piqo. Only attempt to refit Piqo with a new 3M pad when your vehicle is stationary.
- You must route the Piqo power cable (or optional accessory Pro Install Cable or Piqo Quick Connect Cable) appropriately. You must route the power cable (and rear camera cable if you are fitting a Rear Window Camera) so that there is no interference with the deployment of airbags installed on your vehicle. If you impede the deployment of airbags, you will reduce the effectiveness of the secondary protection system which could result in serious injury, death or property damage. You must also ensure that cables do not interfere with vehicle operating controls. If you are hindered from correctly accessing vehicle controls whilst driving, it may cause an accident which could result in serious injury, death or property damage.

WARNING

You should not attempt to manually adjust Piqo's setting whilst driving. Always maintain awareness of your surroundings and do not attempt to adjust Piqo whilst driving. Distractions whilst driving increase the risk of an accident that could lead to serious injury, death or property damage.

CAUTION

Ensure that you check the warranty status for your vehicle before you install the Piqo Quick Connect Cable. Some manufacturers may prohibit the use of OBD-II connections which could void your warranty agreement. NEXTBASE IS NOT RESPONSIBLE FOR ANY COSTS OR EXPENSES ASSOCIATED WITH VOID WARRANTIES OR VEHICLE REPAIRS.

If you experience any change in your vehicle's engine performance after connecting the Piqo Quick Connect Cable, you should disconnect the device as soon as it is safe to do so and contact Nextbase Technical Support. DO NOT CONTINUE TO USE PIQO QUICK CONNECT CABLE IF VEHICLE ENGINE POWER IS AFFECTED

CAUTION

Do not expose Piqo to liquids under any circumstances, doing so may result in the risk of electric shock or fire. Should your Piqo become wet, disconnect it from the Power Cable and allow it to dry naturally. DO NOT ATTEMPT to accelerate drying by external means.

CAUTION

You should only use Piqo in compliance with all applicable laws, including local laws of the country and region in which you reside or in which you use your Piqo. When you use Piqo, you do so at your own initiative and you are responsible for compliance with any applicable laws, including but not limited to applicable privacy and data collection laws, and laws prohibiting or restricting the placement of objects on the windshield of a motor vehicle.

PSTI Statement of Compliance

We, Portable Multimedia Limited t/a Nextbase, hereby declare under our own responsibility that the devices NBPICO1 & NBPICO2 comply with the applicable security requirements in Schedule 1 of The Product Security and Telecommunications Infrastructure (Security Requirements for Relevant Connectable Products) Regulations 2023.

1. Password is unique per device or defined by the user of the device, and the password which is unique per device is generated by using as security mechanism that reduces the risk of automated attacks against a class or type of device.

2. Users can report vulnerabilities to Nextbase as per our Vulnerability Disclosure policy available via <https://nextbase.co.uk/vulnerability-disclosure-policy>, users will receive acknowledgment of the receipt of a security issues report and status updates until the resolution of the reported security issues.

3. We will provide security updates for this product during the support period. The defined support period is listed here <https://nextbase.co.uk/security-maintenance-period-policy>

Place of declaration issue: Caerphilly, UK
 Date of Issue: 15th April 2024
 Issued by: Keelan O'Connor
 Quality and Compliance Manager Nextbase

Signature:

For more information or support visit nextbase.com/hub/tag/support
 This manual is also available at nextbase.com/piqo-install

Product Tech Specs

Resolution: Piqo 1K – 2560 x 1080p
 Piqo 2K – 2560 x 1440p

Operating system requirements: iOS 15 and Android 8

Phone connection technology: Wi-Fi 2.4Ghz and Bluetooth 4.1

GPS: 10Hz

Channels: 1 Channel

Sensor make and model: Omnivision

Field of view: Piqo 1K – 140°

Piqo 2K – 145°

Storage: Piqo 1K – 128GB (12 hours of footage)

Piqo 2K – 256GB (18 hours of footage)

Dimensions: 109 x 40 x 32mm



- Keep your firmware up to date, check in the Nextbase app for updates.
- Do not spray liquids on or near your Nextbase Piqo Dash Cam.

For easy removal from your windscreen, slide your
- Nextbase Piqo Dash Cam off the mount by pulling the Dash Cam towards you.
- Use the cable tidy on the mount to help guide the cable to your vehicle lining.
- Keep the area on the windscreen directly in front of your Dash Cam lens clear and free of dirt.

Still Have some questions?

Click here for more useful information, FAQs and videos

More Piqo Info





piqo

NBDVRPIQO_R1