

# Architect Toaster

Instruction Manual & Guarantee

# Dualit®

Since 1945

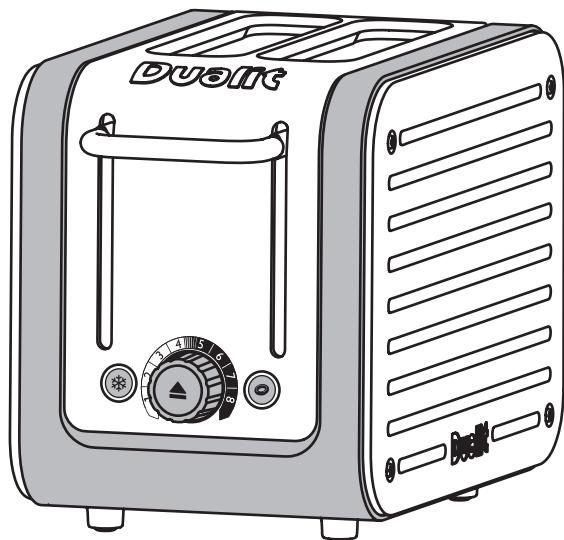

CAT2

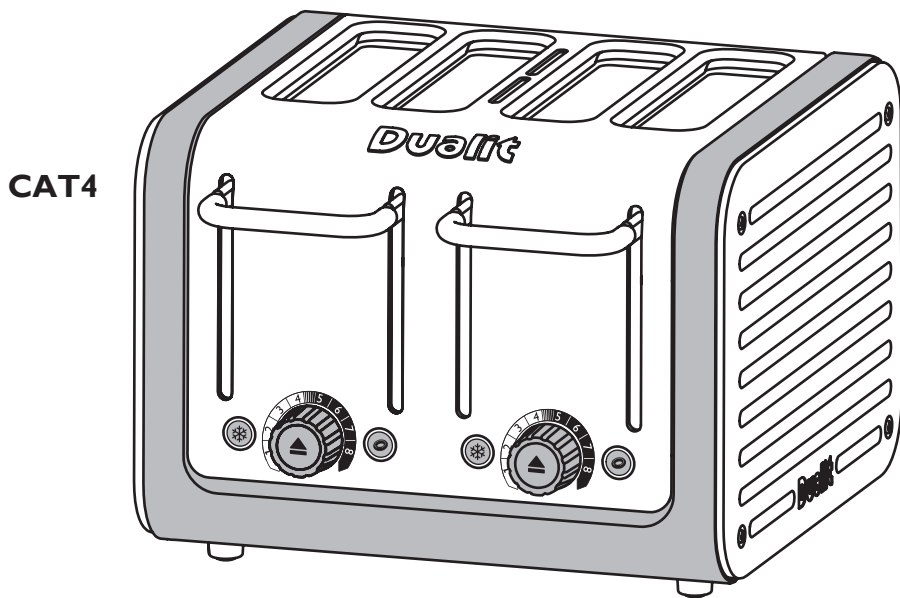

CAT4

# YOUR ARCHITECT TOASTER

The perfect slice of toast is an essential part of breakfast and the Architect toaster is designed to deliver every time. With extra wide slots for the chunkiest of bread, defrost option and patented Peek and Pop® function, you will be serving superior toast, bagels and buns to change the way you breakfast.

Each Architect toaster features interchangeable panels with a wide variety of colours available, allowing you to update the colour of your toaster if you move house, update your kitchen, or simply to suit your mood.

**DON'T FORGET TO  
REGISTER YOUR PRODUCT**

**[WWW.DUALIT.COM/REGISTER](http://WWW.DUALIT.COM/REGISTER)**

	<p><b>OR BY POST</b></p> 
---	---

**Register ✓  
my appliance**

# CONTENTS

Safety precautions _____	04
Know your Toaster _____	06
Setting up _____	08
Toasting tips _____	09
Toasting bread _____	10
Bagel & bun toasting _____	11
Toasting frozen bread _____	12
4 slot toasting _____	13
Stop toasting _____	14
Sandwich cage _____	14
Cleaning & care _____	15
Troubleshooting _____	16
Guarantee _____	18



# IMPORTANT SAFETY PRECAUTIONS



## READ ALL INSTRUCTIONS

BEFORE USING THE TOASTER.

KEEP THESE INSTRUCTIONS FOR FUTURE REFERENCE

## IMPORTANT SAFEGUARDS

- **THIS IS AN ATTENDED APPLIANCE. Do not leave unattended during use, unplug after each use (risk of fire if an unattended appliance is left operating or plugged in).**
- This appliance must not be used by children younger than 8 years old and persons with very extensive and complex disabilities. Children aged 8-14 years and persons with reduced physical, sensory or mental capabilities or lack of experience and knowledge shall not use this appliance, unless they are supervised and have been given instruction concerning the use of the appliance in a safe way and understand the hazards involved. Close supervision is necessary when any appliance is used by or near children. Children shall be supervised to ensure that they do not play with the appliance. Cleaning and user maintenance shall not be made by children unless they are older than 8 and supervised. Keep the appliance and its cord out of reach of children less than 8 years old. **Risk of fire, electric shock, scalding or injury to persons.**
- This appliance is intended for indoor household use only. If the appliance is used improperly or for professional or semi-professional purposes or if it is not used according to these instructions the Guarantee becomes invalid and Dualit refuses any liability for damage caused. **Risk of fire, electric shock, scalding or injury to persons.**

### Electrical safety

- Before plugging in, check that the voltage on the rating label is the same as the mains supply. **Risk of electric shock and fire.**
- Never plug an appliance into a socket/outlet with other appliances connected to it or a socket/outlet with additional features such as, but not limited to, USB sockets, built-in Wi-Fi boosters, remote Wi-Fi/Bluetooth or similar smart switching functionality. Failure to do this may cause an overload, trip a circuit breaker or blow a fuse. **Risk of electric shock and fire or damage to socket/outlet and plug.** The socket/outlet should be protected by a Residual Current Device (RCD).
- Unplug from outlet when not in use and before cleaning. Allow to cool before putting on or taking off parts. **Risk of fire, electric shock, scalding or injury to persons.**

- **Should the neon light remain illuminated after using appliance immediately unplug the toaster and call service centre. Risk of electric shock.**
- The toaster is not intended to be operated by means of an external timer or separate remote-control system. **Risk of fire.**
- To protect against electric shock, do not immerse any part of this product in water or other liquid. **Risk of electric shock.**
- **NOTE:** Any plug cut from the power supply cord should be disposed of immediately. Inserting any cut off plug into a socket-outlet is hazardous. **Risk of electric shock and fire.**
- Do not operate any appliance with a damaged lead or plug, or after the appliance malfunctions, or has been damaged, cracked or dropped in any manner. **Risk of electric shock and fire.**
- In order to avoid a hazard, if the Power Cord is damaged it must, for safety reasons, be replaced by Dualit or a qualified electrician. Call Dualit's Customer Helpline on +44 (0) 1293 652 500. **Risk of electric shock and fire.**
- Never use the plug without the fuse cover fitted. Ensure replacement fuse is the same current value as original. Replacement fuses should be ASTA approved to BS 1362. **Risk of electric shock and fire.**
- **WARNING:** This appliance must be earthed. **Risk of electric shock and fire.**
- Never touch the appliance or Power Cord with wet hands. **Risk of electric shock.**
- The use of extension cables not authorised by the manufacturer may cause damage or accidents. **Risk of electric shock.**

### General safety

- **Do not use foods, including tarts and pastries, that may drip fillings or coatings containing sugar when heated in your toaster, as may cause a fire. Risk of fire.**
- Bread may burn. Therefore toasters must not be used near or below curtains and other combustible materials. **Risk of fire.**
- When in use a fire may occur if the appliance is covered or touching flammable material, including curtains, draperies, walls and the like. **Risk of fire.**
- Do not place on or near a hot gas or electric burner, or in a heated oven. **Risk of fire.**
- Do not attempt to dislodge bread when the toaster is plugged in. **Risk of electric shock.**
- Crumb tray must be in place during toasting. **Risk of fire.**
- Crumb tray should be regularly cleaned, a build up of crumbs can burn or cause a fire. **Risk of fire and injury.**

- Do not allow cable to touch hot surfaces, or to hang over edge of a table or counter top. **Risk of fire or electric shock.**
- Keep the appliance and its cord out of reach of children. **Risk of electric shock, and injury to persons.**
- Do not use appliance for any purpose other than the intended use. **Risk of fire, electric shock, scalding or injury to persons.**
- Do not store or use toaster in an appliance garage or under cupboards. **Risk of fire.**
- Do not use if dropped, cracked or damaged. **Risk of burns and electric shock.**
-  Accessible surfaces of the toaster may get hot during use. Therefore use handles or knobs. **Risk of burns.**
- The appliance will remain hot after use. **Risk of burns.**
- The machine must only be operated on a flat surface. **Risk of fire and electric shock.**
- Do not use scouring pad or abrasive cleaner on the toaster body. **Risk of damage.**
- The use of accessory attachments not recommended by Dualit may result in fire, electric shock or injury to persons.
- Oversized foods, metal foil packages or utensils must not be inserted in or on top of the appliance. **Risk of fire or electric shock.**
- Never put the appliance or part of it in a dishwasher. **Risk of damage and electric shock.**
- Do not put a pan on top of the toaster or warming rack. **Risk of fire, electric shock, scalding or injury to persons.**
- Do not toast bread in slots and use warming rack at the same time. **Risk of fire.**
- Use for a maximum of 3 minutes and then allow to cool between each use.
- Do not allow the device to freeze. This may compromise electrical safety and will degrade performance of all lubricants. **Risk of electric shock and damage.**
- Do not modify the appliance. **Risk of fire and electric shock.**
- Remove all packaging before use. **Risk of fire.**
- Do not insert hands, implements, or any metallic or sharp utensils into the toaster. **Risk of damage and electric shock.**
- Never use the toaster without the interchangeable panels correctly assembled. Architect toasters only. **Risk of burns.**

## SAVE THESE INSTRUCTIONS

In the interest of improving products, Dualit Ltd. reserves the right to change the product specification without prior notice. All illustrations are for representation only, your model may vary from illustrations shown.



### INSTRUCTIONS ON ENVIRONMENT PROTECTION

Do not dispose this product in the usual household garbage at the end of its life cycle. Please hand it over to a collection point for the recycling of electrical and electronic appliances. The symbol on the product, the instruction of use or the packaging will inform you about the methods of disposal. The materials are recyclable as mentioned on its marking. By recycling, material recycling or other forms of re-utilization of old appliances you are making an important contribution to protect our environment. Please enquire at the community administration for the authorised disposal location.

## IMPORTANT: BEFORE FIRST USE

- Read this instruction manual before you start using the toaster. It gives you important safety information and will ensure you get the most out of your Dualit toaster.
- Keep this manual and your proof of purchase in a safe place.
- Don't forget to register your product at [www.dualit.com/register](http://www.dualit.com/register).
- Before you use your toaster for the first time, clean all parts according to the cleaning instructions.
- Position the toaster according to the safety precautions. **Risk of fire, electric shock, scalding or injury to persons.**
- Make sure the toasting lever is in the raised position when you put the plug into the wall socket. **Risk of fire and electric shock.**
- The toasting lever will only engage when the toaster is plugged in with the power on.
- The cancel button will illuminate to show that the toaster is heating.
- To condition the elements for use, let the toaster complete the first cycle without slices of bread in it and allow to cool to room temperature.
- If using the optional warming rack, read the instruction manual included with the warming rack.

# KNOW YOUR TOASTER

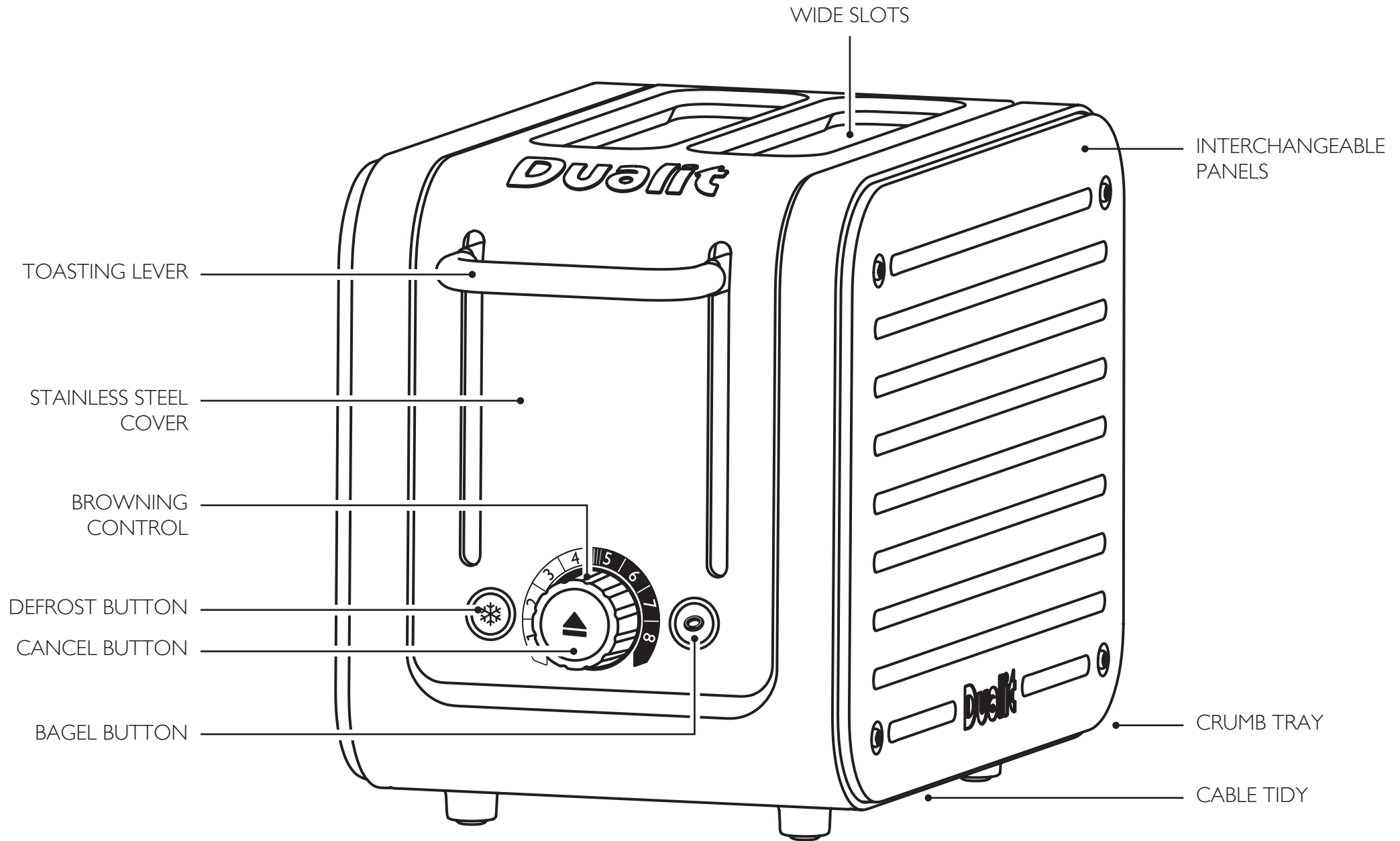

# SETTING UP

Read and follow these instructions before using your toaster.

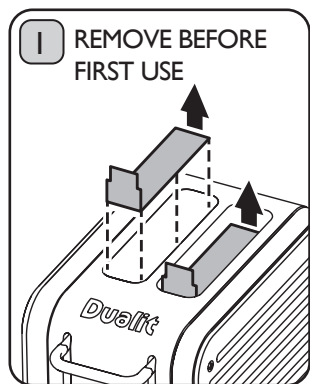
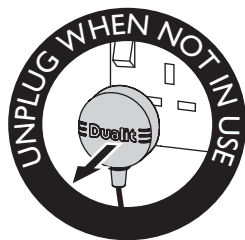

Ensure your toaster is unplugged and cool. **REMOVE CARDBOARD INSERTS FROM THE SLOTS BEFORE FIRST USE.** A fire may occur if incorrectly positioned.

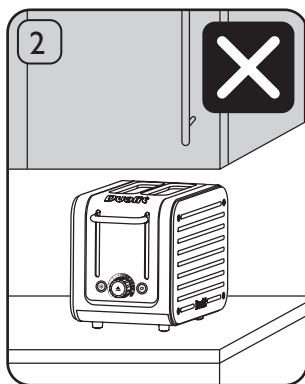

**DO NOT STORE OR USE YOUR TOASTER IN AN APPLIANCE GARAGE OR UNDER CUPBOARDS.** A fire may occur if incorrectly positioned.

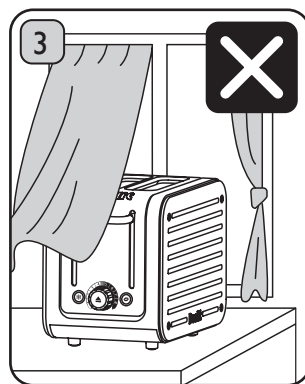

**DO NOT STORE OR USE YOUR TOASTER CLOSE TO CURTAINS OR FLAMMABLE MATERIAL.** A fire may occur if incorrectly positioned.

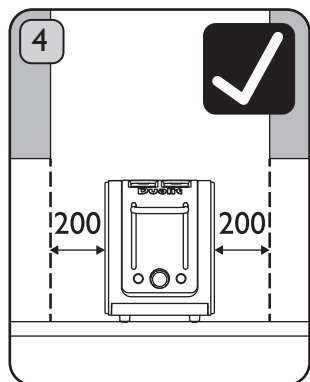

Place the toaster on an open level surface. Ensure the toaster is positioned at least **200mm CLEAR FROM ANY OVERHANGING CUPBOARDS OR WALLS.**

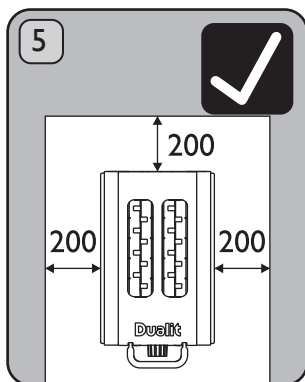

Ensure the toaster is positioned at least **200mm CLEAR FROM ANY OVERHANGING CUPBOARDS OR WALLS.**

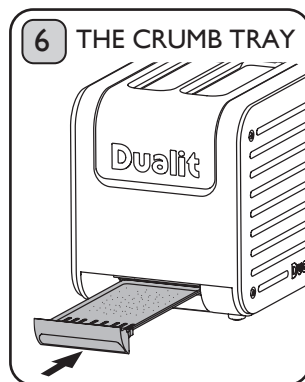

**CRUMB TRAY MUST BE IN PLACE DURING TOASTING.**

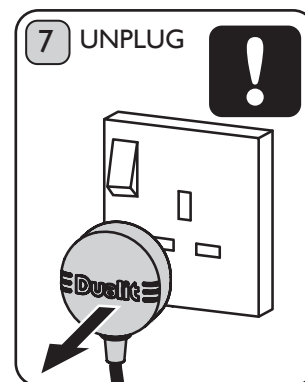

**UNPLUG WHEN NOT IN USE.**



**DON'T FORGET TO REGISTER YOUR TOASTER AT [WWW.DUALIT.COM/REGISTER](http://WWW.DUALIT.COM/REGISTER) OR BY POST**

## TOASTING TIPS

Here are a few tips to help get the best out of your toaster.

- Different breads will toast at different rates, wholemeal bread takes longer than white bread, fresh bread will take longer than day old bread. Remember to adjust your browning control to allow for your particular type of bread.
- After the first round of toast, the elements and toaster body will be heated up, subsequent rounds will take less time to toast.
- At any time during the toasting cycle you can lift the toasting lever and check the progress of the toasting.
- Use the bagel setting to toast burger buns, bagels, muffins or tea cakes, this setting toasts one side whilst gently warming the other.
- The thickest slice of bread that will fit in your toaster is 36mm thick. Forcing bread which is too thick or too long into the slots will be difficult to eject once toasted.
- You may find it easier to use a 'sandwich cage' to toast smaller items. Inserting and removing items will be easier (sold separately).
- When hand cutting a fresh loaf, cut the slices as evenly as possible. Uneven slices will toast unevenly.
- Keep elements free from breadcrumbs and broken pieces of bread. If left these may burn out the elements. With the toaster unplugged use a soft brush to clean inside your toaster, do not use a knife!
- To reheat recently made toast set the browning control to 1.
- Cancel toasting manually at any time by pressing the cancel button on the browning control knob.

# TOASTING BREAD

THIS IS AN ATTENDED APPLIANCE. **Do not leave unattended during use, unplug after each use (risk of fire if an unattended appliance is left operating).**

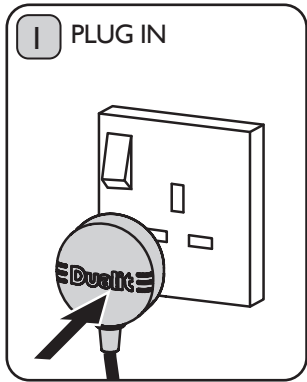

The toaster will only engage when the power is switched on. Plug the toaster into the wall power socket and turn power on at socket.

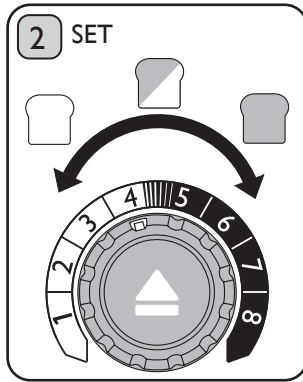

To toast, set the desired browning level by means of the browning control (1 is the lightest and 8 is the darkest setting).

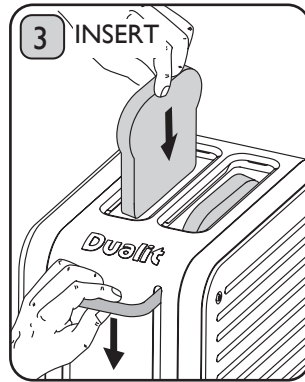

Place the bread into the slots and press the toasting lever down until it engages. The browning control will be illuminated blue for the duration of the toasting.

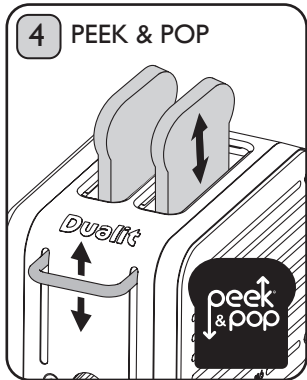

At any time during the toasting cycle you can lift the toasting lever and check the progress of the bread. **If you remove the toast before the cycle is complete, press the cancel button and unplug.**

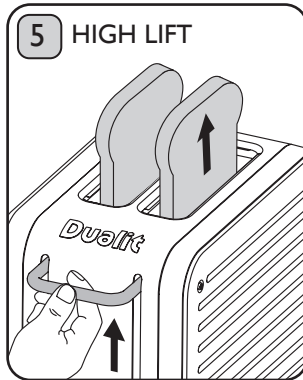

When toasted the toast will pop up automatically. If the slices are difficult to remove safely, lift the toasting lever up manually for extra high lift.

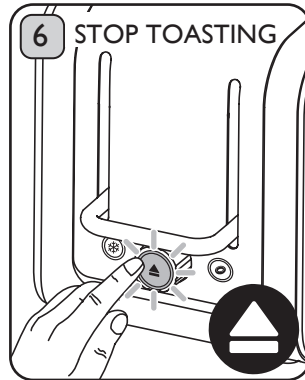

To immediately stop toasting, press the cancel button. **After cancelling if neon light remains illuminated after use immediately unplug the toaster & call service centre.**

# BAGEL & BUN TOASTING

Perfectly toast bagels or other bread products such as buns, English muffins or teacakes. This feature gently warms the outside of the item and toasts the inside to perfection. **To cancel toasting see page 14.**

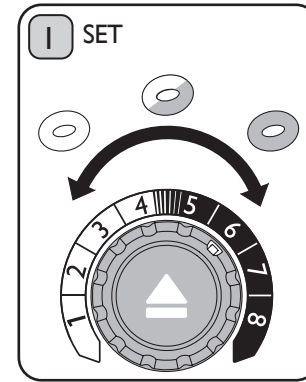

Select the desired browning level. (1 is the lightest and 8 is the darkest setting).

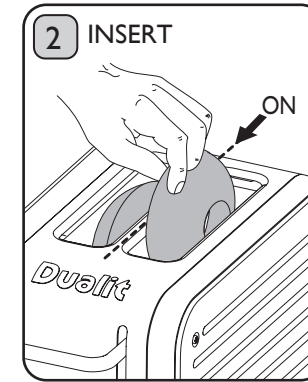

Slice bagel into two equal halves before toasting. Insert bagel so both 'cut' sides are facing inwards to the centre element.

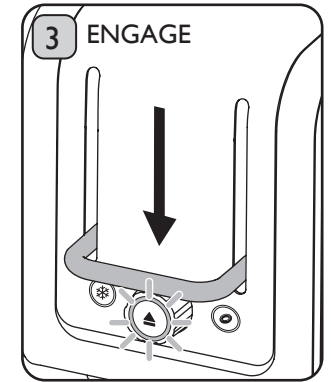

Press the toasting lever down until it engages. The browning control will be illuminated blue.

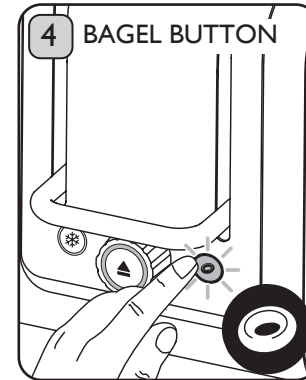

As soon as the bagel is lowered, immediately press the bagel button. The button will be illuminated blue and only the centre element will heat up.

# TOASTING FROZEN BREAD

When 'defrost' is activated, the toaster automatically adjusts the settings to defrost and then toast frozen bread.

To cancel toasting see page 14.

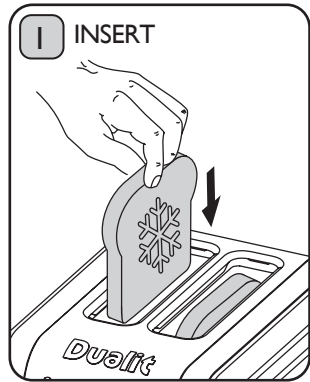

To toast frozen bread, place the bread into the slots.

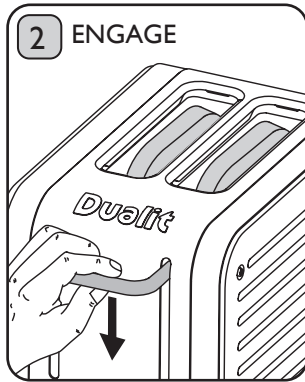

Press the toasting lever down until it engages.

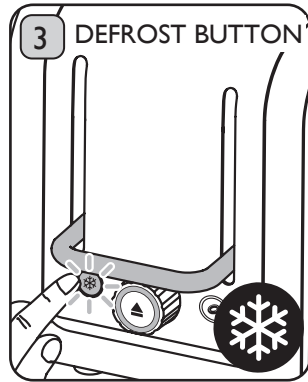

Immediately press the defrost button. The button will be illuminated blue. To toast frozen bagels or buns, engage the toasting lever then press both defrost and bagel buttons.

# 4 SLOT TOASTING

To cancel toasting see page 14.

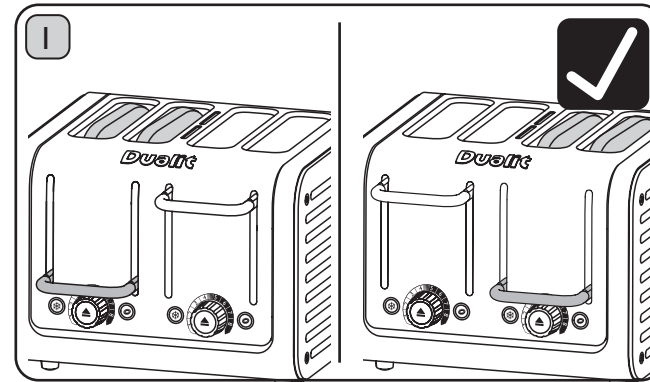

If you want to toast 2 pieces of bread only **LOAD AND ENGAGE** one side of the toaster.

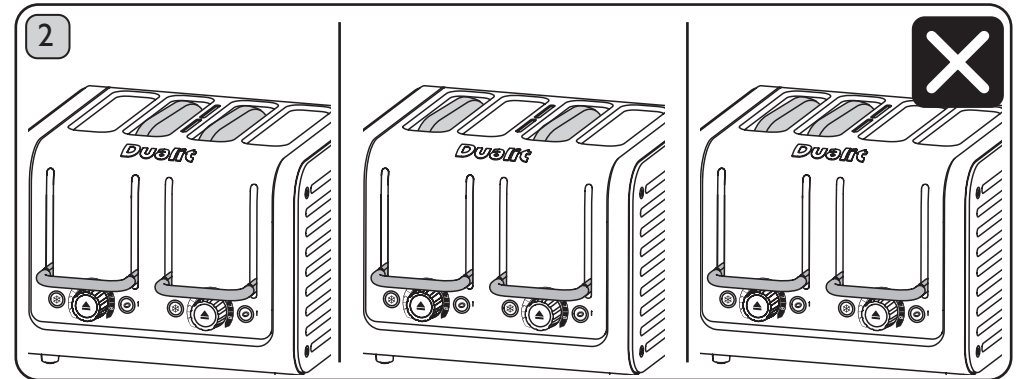

**DO NOT LOAD AND ENGAGE BOTH SIDES OF THE TOASTER TO TOAST 2 PIECES OF BREAD.**

# STOP TOASTING

The toasting cycle will automatically stop and the toast will pop up, but if required you can cancel at any time.

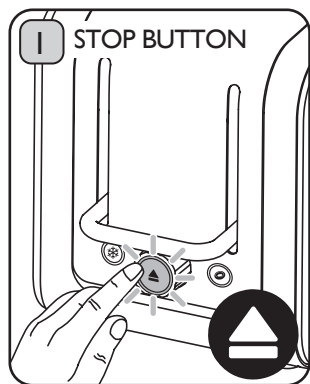

Press the cancel button located on the end of the browning control.

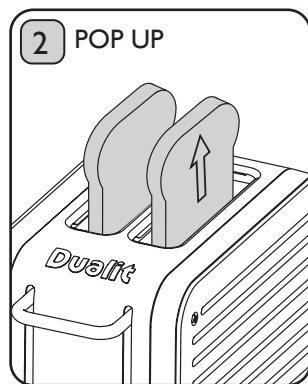

The toaster will immediately stop and the items being toasted will pop up. **The neon will go out. After cancelling if neon light remains illuminated after use immediately unplug the toaster & call service centre.**

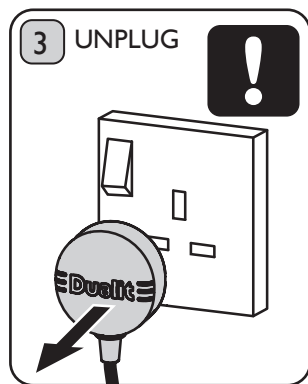

**THIS IS AN ATTENDED APPLIANCE. Do not leave unattended during use, unplug after each use (risk of fire if an unattended appliance is left operating).**

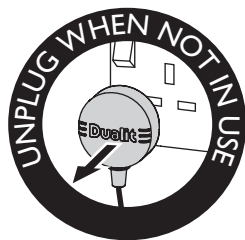

# CLEANING & CARE

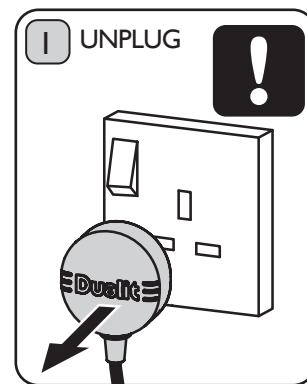

Switch toaster off, remove the plug from the wall socket and let the toaster cool down before you start cleaning it.



Wipe the outside of the toaster with a moist cloth and dry it with another cloth. Do not use a scouring pad or abrasive cleaner.



Use a soft brush to clean inside your toaster. Do not insert any metallic or sharp utensils in to the toaster.



# SANDWICH CAGE OPTIONAL EXTRA

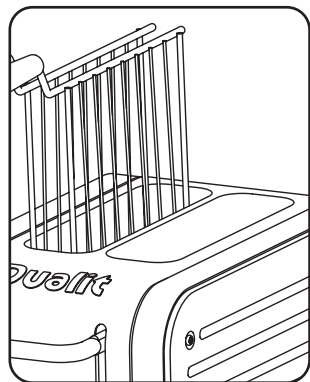

The sandwich cage provides you with the option of making toasted sandwiches in your Architect toaster. It is also useful for toasting smaller items like buns, bagels and teacakes. Each pack includes a free cookbook with a range of ideas for deep filled toasted sandwiches that make good use of the extra-wide slots of your Architect toaster.

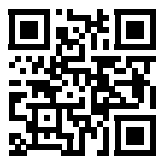

AVAILABLE AT:  
[WWW.DUALIT.COM](http://WWW.DUALIT.COM)

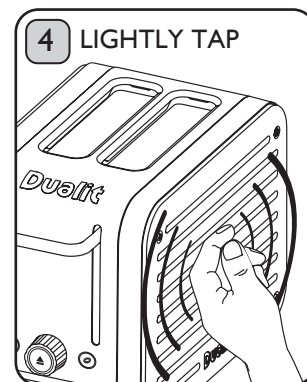

When the toaster has cooled completely, tap the sides of the toaster lightly to dislodge any crumbs caught in the toasting chamber.

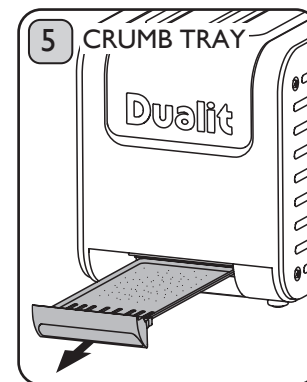

Crumbs will accumulate in the crumb tray and could catch fire if the tray is not emptied frequently. Pull out the crumb tray and wipe clean using a damp cloth.

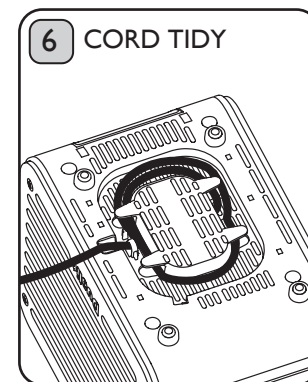

Store the cleaned toaster unplugged with the cord wrapped round the cord tidy on the base of the toaster.





# GUARANTEE

This appliance is of excellent quality and construction. However, if any defects in materials or workmanship do appear during the relevant guarantee period, we will, at our discretion, either repair or replace the defective parts, free of charge, subject to the terms and conditions of our Guarantee shown below.

This Guarantee covers both parts and labour. Carriage is not included.

Your Guarantee period is as follows:

- 1 year

This Guarantee provides benefits which are additional to, and do not affect, your statutory rights. This Guarantee does not cover the cost of returning the product to the dealer from whom it was purchased or to ourselves. This Guarantee applies only to products sold and located in mainland Great Britain. It does not cover liability in respect of or replacement of plugs, cables or fuses and also does not cover defects due to:

- Failure to use or maintain product in accordance with Dualit's instructions.
- The product being connected to an unsuitable electricity supply.
- Accidental damage to or abuse or misuse of the product.
- product modification, except by Dualit or approved agent.
- Dismantling of or interference with the product.
- Theft or attempted theft of the product.

Before returning any product under this Guarantee, please check that:

- You have followed the product instructions correctly.
- Your mains electricity supply is functional.
- The defect is not due to a blown fuse.

If you wish to claim under this guarantee you should:

- Send the product, postage or carriage paid, to the dealer from whom it was purchased or to Dualit direct.
- Ensure that the product is clean and packed carefully (preferably in its original carton).
- Enclose details of your name, address and telephone number and when and where the product was purchased, together with proof of purchase (e.g. a till receipt).
- Give exact details of the nature of the defect.

This Guarantee does not cover any other claims whatsoever, including, without limitation, any liability for incidental, indirect or consequential damage, nor does it cover any claims for conversion or modification or for the costs of repair carried out by any third party without the prior consent of Dualit. If replacement parts are fitted to the product this will not extend the period of the Guarantee.

For further advice contact the Dualit customer helpline on +44 (0)1293 652 500 (09:00 to 17:00 Monday to Friday).

Alternatively, email Dualit at [info@dualit.com](mailto:info@dualit.com) or visit [www.dualit.com](http://www.dualit.com)

Do not throw away the appliance with the normal household waste at the end of its life, but hand it in to an official collection point for recycling. By doing this you help preserve the environment.

## REGISTER YOUR PRODUCT

1. **Fast and efficient customer service** and access to manuals and product information should you require assistance with your purchase.
2. Access to a library of mouth-watering recipes and regular articles on Dualit products, events, competitions and much more.
3. **Be the first to receive the latest news** about exciting new Dualit products.



DON'T FORGET  
TO REGISTER  
YOUR PRODUCT

[WWW.DUALIT.COM/REGISTER](http://WWW.DUALIT.COM/REGISTER)

OR BY POST



# Dualit®

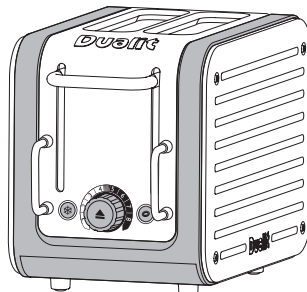

Architect toasters comply with Australian Deviation AS/NZS 60335.2.9 2009 (A1) requirement.



Dualit Limited County Oak Way Crawley West Sussex RH11 7ST  
+44(0)1293 652 500 info@dualit.com